



## USER MANUAL

VERSION: V1.0.0

# CTC-1402

Connectivity and Transport Kit - Conferencing



## IMPORTANT SAFETY INSTRUCTIONS

1. READ these instructions.
2. KEEP these instructions.
3. HEED all warnings.
4. FOLLOW all instructions.
5. DO NOT use this apparatus near water.
6. CLEAN ONLY with dry cloth.
7. DO NOT block any ventilation openings. Install in accordance with the manufacturer's instructions.
8. DO NOT install near any heat sources such as radiators, heat registers, stoves, or other apparatus (including amplifiers) that produce heat.
9. DO NOT defeat the safety purpose of the polarized or grounding type plug. A polarized plug has two blades with one wider than the other. A grounding type plug has two blades and a third grounding prong. The wider blade or the third prong are provided for your safety. If the provided plug does not fit into your outlet, consult an electrician for replacement of the obsolete outlet.
10. PROTECT the power cord from being walked on or pinched, particularly at plugs, convenience receptacles, and the point where they exit from the apparatus.
11. ONLY USE attachments/accessories specified by the manufacturer.



12. USE ONLY with a cart, stand, tripod, bracket, or table specified by the manufacturer, or sold with the apparatus. When a cart is used, use caution when moving the cart/apparatus combination to avoid injury from tip-over.
13. UNPLUG this apparatus during lightning storms or when unused for long periods of time.
14. REFER all servicing to qualified service personnel. Servicing is required when the apparatus has been damaged in any way, such as power-supply cord or plug is damaged, liquid has been spilled or objects have fallen into the apparatus, the apparatus has been exposed to rain or moisture, does not operate normally, or has been dropped.
15. DO NOT expose this apparatus to dripping or splashing and ensure that no objects filled with liquids, such as vases, are placed on the apparatus.
16. To completely disconnect this apparatus from the AC Mains, disconnect the power supply cord plug from the AC receptacle.
17. Where the mains plug or an appliance coupler is used as the disconnect device, the disconnect device shall remain readily operable.
18. DO NOT overload wall outlets or extension cords beyond their rated capacity as this can cause electric shock or fire.



The exclamation point, within an equilateral triangle, is intended to alert the user to the presence of important operating and maintenance (servicing) instructions in the literature accompanying the product.



The lightning flash with arrowhead symbol within an equilateral triangle is intended to alert the user to the presence of uninsulated "dangerous voltage" within the product's enclosure that may be of sufficient magnitude to constitute a risk of electrical shock to persons.



ESD Warning: The icon to the left indicates text regarding potential danger associated with the discharge of static electricity from an outside source (such as human hands) into an integrated circuit, often resulting in damage to the circuit.

- WARNING:** To reduce the risk of fire or electrical shock, do not expose this apparatus to rain or moisture.
- WARNING:** No naked flame sources - such as candles - should be placed on the product.
- WARNING:** Equipment shall be connected to a MAINS socket outlet with a protective earthing connection.
- WARNING:** To reduce the risk of electric shock, grounding of the center pin of this plug must be maintained.

## COPYRIGHT NOTICE

AMX© 2018, all rights reserved. No part of this publication may be reproduced, stored in a retrieval system, or transmitted, in any form or by any means, electronic, mechanical, photocopying, recording, or otherwise, without the prior written permission of AMX. Copyright protection claimed extends to AMX hardware and software and includes all forms and matters copyrightable material and information now allowed by statutory or judicial law or herein after granted, including without limitation, material generated from the software programs which are displayed on the screen such as icons, screen display looks, etc. Reproduction or disassembly of embodied computer programs or algorithms is expressly prohibited.

## LIABILITY NOTICE

No patent liability is assumed with respect to the use of information contained herein. While every precaution has been taken in the preparation of this publication, AMX assumes no responsibility for error or omissions. No liability is assumed for damages resulting from the use of the information contained herein. Further, this publication and features described herein are subject to change without notice.

## AMX WARRANTY AND RETURN POLICY

The AMX Warranty and Return Policy and related documents can be viewed/downloaded at [www.amx.com](http://www.amx.com).

## ESD WARNING



To avoid ESD (Electrostatic Discharge) damage to sensitive components, make sure you are properly grounded before touching any internal materials.

When working with any equipment manufactured with electronic devices, proper ESD grounding procedures must be followed to make sure people, products, and tools are as free of static charges as possible. Grounding straps, conductive smocks, and conductive work mats are specifically designed for this purpose. These items should not be manufactured locally, since they are generally composed of highly resistive conductive materials to safely drain static discharges, without increasing an electrocution risk in the event of an accident.

Anyone performing field maintenance on AMX equipment should use an appropriate ESD field service kit complete with at least a dissipative work mat with a ground cord and a UL listed adjustable wrist strap with another ground cord.



### CAUTION

RISK OF ELECTRIC SHOCK  
DO NOT OPEN



**WARNING:** Do Not Open! Risk of Electrical Shock. Voltages in this equipment are hazardous to life. No user-serviceable parts inside. Refer all servicing to qualified service personnel.

Place the equipment near a main power supply outlet and make sure that you can easily access the power breaker switch.

**WARNING:** This product is intended to be operated ONLY from the voltages listed on the back panel or the recommended, or included, power supply of the product. Operation from other voltages other than those indicated may cause irreversible damage to the product and void the products warranty. The use of AC Plug Adapters is cautioned because it can allow the product to be plugged into voltages in which the product was not designed to operate. If the product is equipped with a detachable power cord, use only the type provided with your product or by your local distributor and/or retailer. If you are unsure of the correct operational voltage, please contact your local distributor and/or retailer.

## FCC AND CANADA EMC COMPLIANCE INFORMATION:

This device complies with part 15 of the FCC Rules.

Operation is subject to the following two conditions:

(1) This device may not cause harmful interference, and (2) this device must accept any interference received, including interference that may cause undesired operation.

NOTE: This equipment has been tested and found to comply with the limits for a Class A digital device, pursuant to part 15 of the FCC Rules. These limits are designed to provide reasonable protection against harmful interference in a commercial environment. This equipment generates, uses and can radiate radio frequency energy and, if not installed and used in accordance with the instructions, may cause harmful interference to radio communications. However, there is no guarantee that interference will not occur in a particular installation. If this equipment does cause harmful interference to radio or television reception, which can be determined by turning the equipment off and on, the user is encouraged to try to correct the interference by one or more of the following measures:

- Reorient or relocate the receiving antenna.
- Increase the separation between the equipment and receiver.
- Connect the equipment into an outlet on a circuit different from that to which the receiver is connected.
- Consult the dealer or an experienced radio/TV technician for help.

Approved under the verification provision of FCC Part 15 as a Class A Digital Device.

Caution

Changes or modifications not expressly approved by the manufacturer could void the user's authority to operate this device.

CAN ICES-3 (B)/NMB-3(B)

## EU COMPLIANCE INFORMATION:

Eligible to bear the CE mark; Conforms to European Union Low Voltage Directive 2006/95/EC; European Union EMC Directive 2004/108/EC; European Union Restriction of Hazardous Substances Recast (RoHS2) Directive 2011/65/EU; European Union WEEE (recast) Directive 2012/19/EU; European Union Radio and Telecommunications Terminal Equipment (R&TTE) Directive 1999/5/EC

## WEEE NOTICE:



This appliance is labeled in accordance with European Directive 2012/19/EU concerning waste of electrical and electronic equipment (WEEE). This label indicates that this product should not be disposed of with household waste. It should be deposited at an appropriate facility to enable recovery and recycling.

# Table of Contents

Important Safety Instructions .....	2
Overview .....	6
Features .....	6
Package Contents .....	6
Specifications .....	7
Transmitter Front Panel Description .....	10
Transmitter Rear Panel Description.....	12
Receiver Front Panel Description .....	13
Receiver Rear Panel Description .....	14
Pinout Information .....	15
RS232 .....	15
RELAY .....	15
Audio Out .....	16
Installation.....	17
Wiring .....	18
OSD.....	19
Input Source Switching.....	20
Auto Switching .....	20
Manual Switching.....	20
USB Control .....	21
NetLinx Studio Control .....	24
Device Number and Ports .....	24
Send Commands to Control a Device.....	26
Telnet Control via NetLinx Studio .....	26
Web UI Control.....	28
Web UI Control .....	29
Access the Web Interface .....	29
Web Interface Introduction .....	30
Refresh.....	30
Factory Default .....	30
Reboot .....	30
Upgrade Status .....	31
LOGOUT .....	31
Firmware VERSION.....	31
Auto Switch: .....	31
Key Lock .....	31

HDCP .....	31
EDID .....	32
Display .....	32
RS232 Setting .....	32
Relay .....	33
Audio Volume .....	34
Resolution.....	34
Network .....	35
System .....	36
ICSP Parameter .....	36
Login Password .....	36
TELNET/SSH Access .....	37
TELNET Account.....	37
SSH Account.....	37
Firmware Upgrade .....	38
Before Starting.....	38
Transferring KIT Files.....	38
Troubleshooting.....	40
API Command Set .....	41
NetLinx Commands .....	42
Telnet/SSH Commands.....	50

# Overview

The CTC-1402 is a 4K 6x Multi-format Inputs Extender Switch with USB extension and includes a scaler for CTC-1402. The transmitter and receiver kit offers six video inputs shared between both devices for HDMI, Display Port, VGA plus analog audio in and USB-C video signals. To simplify conference room device management, the kit provides four USB type B connectors for host Computers. Six built-in USB hubs, three on the transmitter and three on the receiver, allow for the use of numerous Human Interface Devices (HID) as well as USB cameras and microphones.

The kit is compatible with sources up to 4K / 60Hz with 4:4:4 color subsampling. All audio, video, data, control, USB, and Ethernet transmission between the two devices is carried over a single, Ethernet-enabled HDBaseT link up to 328 feet (100 meters).

The CTC-1402 simplifies classroom and small office system integration, for installation beneath conference tables and in lecterns, to provide localized presentation switching support.

## Features

- Built-in scaler and DSC
- Supports up to 4K@60Hz 4:4:4 8bit HDMI In/Out
- Supports HDMI 2.0 and HDCP 2.2
- Provides a variety of interfaces, including USB-C, to simplify meeting room devices management
- Supports USB hosts like Desktop and Laptop, USB devices like keyboard/MIC/Speaker/Camera/Whiteboard for conference systems
- Automatically detects active inputs when sources are connected or there is a source signal change
- Ethernet can be imported from either receiver or transmitter, providing LAN accessibility for users
- The source device with USB-B or connected with USB-C will be controlled by the USB device via video auto-detection technology
- Control or upgrade via Harman NetLinx studio, Control of 3rd party devices via serial port of the CTC-1402
- Allows control of connected displays On/Off via CEC by using NetLinx studio or front panel buttons
- Allows control relay such as the raising and lowering of project screens
- RS232 bi-directional pass through
- IR pass through from TX to RX
- De-embedded Audio Out/In Receiver
- Supports fast switch

## Package Contents

- 1 x CTC – 1402 Transmitter
- 1 x CTC – 1402 Receiver
- 2 x DC 12V Power Adapter (with US, UK, EU Power Cords)
- 1 x Broadband IR Receiver (30KHz-50KHz)
- 1 x IR Emitter
- 8 x Phoenix Male Connector (3.5mm, 3 Pins)
- 1 x Phoenix Male Connector (3.5mm, 2 Pins)
- 4 x Mounting Bracket (with Screws)

# Specifications

## Transmitter

Technical	
Input	1 x HDMI IN 1 x DisplayPort IN 1 x USB-C IN 1 x VGA IN 1 x Audio IN (followed with VGA IN)
Input Signal Type	HDMI with 4K@60Hz 4:4:4 8bit, HDCP 2.2; DP/USB-C : DP 1.2a
Input Resolution Supported	HDMI Input Resolution supported:  VESA: 800x600 <sup>8</sup> , 1024x768 <sup>8</sup> , 1280x768 <sup>8</sup> , 1280x800 <sup>8</sup> , 1280x960 <sup>8</sup> , 1280x1024 <sup>8</sup> , 1360x768 <sup>8</sup> , 1366x768 <sup>8</sup> , 1440x900 <sup>8</sup> , 1600x900 <sup>8</sup> , 1600x1200 <sup>8</sup> , 1680x1050 <sup>8</sup> 1920x1080 <sup>8</sup> , SMPTE: 1920x1200 <sup>8</sup> , 2560x1440 <sup>8</sup> , 2560x1600 <sup>8</sup> 3840x2160 <sup>p2,3,5,6,8(YUV4:2:0)</sup> , 4096x2160 <sup>2,3,5,6,8 (YUV 4:2:0)</sup> , 1 = at 23.98 Hz, 2 = at 24 Hz, 3 = at 25 Hz, 4 = at 29.97 Hz, 5 = at 30 Hz, 6 = at 50 Hz, 7 = at 59.94 Hz, 8 = at 60 Hz  Established Timing including interlaced formats:  1280 x 1024 @ 75 Hz 1152 x 870 @ 75 Hz 1024 x 768 @ 60 Hz, 70 Hz, 75 Hz, 87 Hz 832 x 624 @ 75 Hz 800 x 600 @ 56 Hz, 60 Hz, 72 Hz, 75 Hz 720 x 400 @ 70 Hz, 88 Hz 640 x 480 @ 60 Hz, 67 Hz, 72 Hz, 75 Hz  CEA Video Information Code (VIC) Formats: VIC = 1, 640 x 480p 59.94/60 Hz 4:3 VIC = 2, 720 x 480p 59.94/60 Hz 4:3 VIC = 3, 720 x 480p 59.94/60 Hz 16:9 VIC = 4, 1280 x 720p 59.94/60 Hz 16:9 VIC = 5, 1920 x 1080i 59.94/60 Hz 16:9 VIC = 6, 720(1440) x 480i 59.94/60 Hz 4:3 VIC = 7, 720(1440) x 480i 59.94/60 Hz 16:9 VIC = 14, 1440 x 480p 59.94/60 Hz 4:3 VIC = 15, 1440 x 480p 59.94/60 Hz 16:9 VIC = 16, Native 1920 x 1080p 59.94/60 Hz 16:9 VIC = 17, 720 x 576p 50 Hz 4:3 VIC = 18, 720 x 576p 50 Hz 16:9 VIC = 19, 1280 x 720p 50 Hz 16:9 VIC = 20, 1920 x 1080i 50 Hz 16:9 VIC = 21, 720(1440) x 576i 50 Hz 4:3 VIC = 22, 720(1440) x 576i 50 Hz 16:9 VIC = 29, 1440 x 576p 50 Hz 4:3 VIC = 30, 1440 x 576p 50 Hz 16:9 VIC = 31, 1920 x 1080p 50 Hz 16:9 VIC = 32, 1920 x 1080p 23.97/24 Hz 16:9 VIC = 33, 1920 x 1080p 25 Hz 16:9 VIC = 34, 1920 x 1080p 29.97/30 Hz 16:9 VIC = 39, 1920 x 1080i 50 Hz 16:9 VIC = 41, 1280 x 720p 100 Hz 16:9 VIC = 42, 720 x 576p 100 Hz 4:3 VIC = 43, 720 x 576p 100 Hz 16:9 VIC = 44, 720(1440) x 576i 100 Hz 4:3 VIC = 45, 720(1440) x 576i 100 Hz 16:9 VIC = 47, 1280 x 720p 119.88/120 Hz 16:9 VIC = 48, 720 x 480p 119.88/120 Hz 4:3 VIC = 49, 720 x 480p 119.88/120 Hz 16:9  VGA Input Resolution supported: Up to 1920 x 1200 @ 60Hz
Input Video Level	0.5-1.0 V p-p
Maximum Pixel Clock	600 MHz
Output	1 x HDBT OUT

Output Signal Type	HDMI with 4k@60Hz 4:4:4 8-bit HDBT 2.0
Video Impedance	100 Ω
Audio Format Support-ed	PCM 2.0
<b>General</b>	
Operating Temperature	0°C to 50°C (32°F to 125.6°F)
Storage Temperature	-10°C to 60°C (14°F to 140°F)
Humidity	5% to 85%, non-condensing
ESD Protection	Human-body Model: ±10kV(Air-gap discharge)/±5kV(Contact discharge)
Surge Protection	Voltage: ±1 kV
Power Supply	12V, 3A
Power Consumption (Max)	2K: 13.36W 4K: 17.38W (4K full loaded)
Device Dimension (W x H x D)	220mm x 42mm x 160mm /8.66" x 1.65" x 6.30"
Product Weight	0.97kg/2.14lb
Certification	CE/FCC/ETL/PSE/RCM

## Receiver

<b>Technical</b>	
Input	1 x HDBT IN 2 x HDMI IN
Input Signal Type	HDMI with 4k@60Hz with Chroma sub-sampling 4:4:4 8bit HDBT 2.0
Resolution Support	VESA: 800x600 <sup>8</sup> , 1024x768 <sup>8</sup> , 1280x768 <sup>8</sup> , 1280x800 <sup>8</sup> , 1280x960 <sup>8</sup> , 1280x1024 <sup>8</sup> , 1360x768 <sup>8</sup> , 1366x768 <sup>8</sup> , 1400x1050 <sup>8</sup> , 1440x900 <sup>8</sup> , 1600x900 <sup>8</sup> , 1600x1200 <sup>8</sup> , 1680x1050 <sup>8</sup> , 1920x1080 <sup>8</sup> , 1920x1200 <sup>8</sup> , SMPTE: 1280x720 <sup>6,8</sup> , 1920x1080P <sup>6,7,8</sup> , 3840x2160 <sup>2,3,5,6,8</sup> , 4096x2160 <sup>2,3,5,8</sup>  1 = at 23.98 Hz, 2 = at 24 Hz, 3 = at 25 Hz, 4 = at 29.97 Hz, 5 = at 30 Hz, 6 = at 50 Hz, 7 = at 59.94 Hz, 8 = 60 Hz;
Input Video Level	0.5-1.0 V p-p
Maximum Pixel Clock	600MHz
Output	1 x HDMI OUT
Output Signal Type	HDMI
Video Impedance	100 Ω
Audio Format Supported	PCM 2.0
<b>General</b>	
Operating Temperature	0°C to 50°C (32°F to 125.6°F)
Storage Temperature	-10°C to 60°C (14°F to 140°F)
Humidity	5% to 85%, non-condensing
Surge Protection	Voltage: ±1 kV



Power Supply	DC12V 3A
Power Consumption (Maximum)	2K: 22.8W 4K: 25.36W
Device Dimension (W x H x D)	220mm x 42mm x 160mm /8.66" x 1.65" x 6.30"
Product Weight	0.95kg/2.09lb
ESD Protection	Human-body Model:
±10kV(Air-gap discharge)	0.97kg/2.14lb
±5kV(Contact discharge)	CE/FCC/ETL/PSE/RCM
Certification	CE/FCC/ETL/PSE/RCM

**Transmission Distance:**

**Note:** Straight-through category cables wired to T568B standard recommended.

Cable Type	Range	Supported Video
HDMI	Input/Output: 15m/50ft	1080p@60Hz, 24bpp
	Input/ Output: 10m/33ft	4K@30Hz 4:4:4
	Input/Output: 5m/16ft	4K@60Hz, 4:4:4
Shielded Cat 6a/7	100m/330ft	1080p@60Hz
	80m/ 262 ft	4K@30Hz, 4:4:4 4K@60Hz, 4:2:0 4K@30Hz, 4:4:4

# Transmitter Front Panel Description

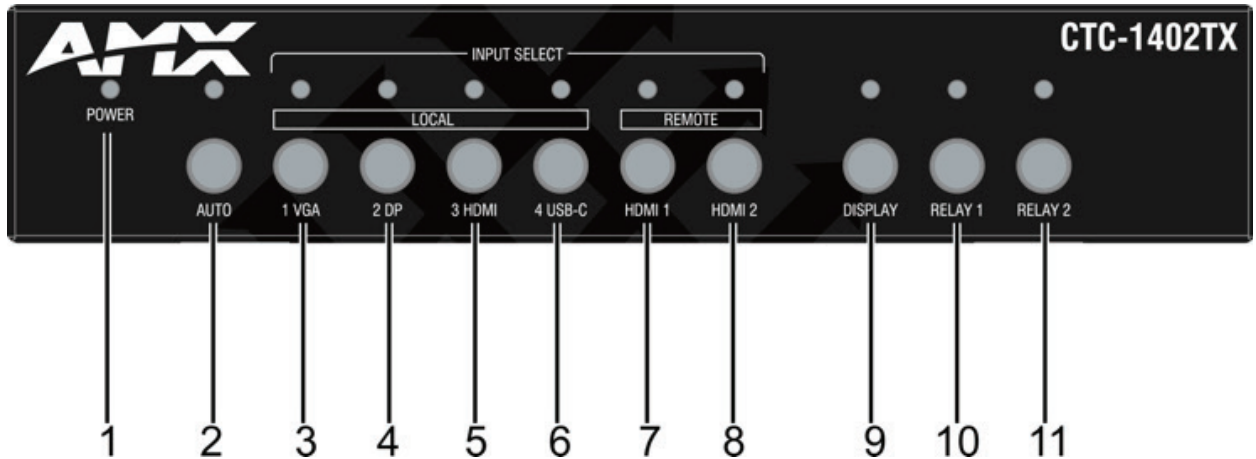

No.	Name	Description
1	POWER LED (Green)	<b>On:</b> The CTC-1402 TX is powered on. <b>Off:</b> The CTC-1402 TX is powered off.
2	Auto	<b>Auto Switch Button:</b> Press to enable/disable auto switching function. <b>LED (Blue):</b> LED is located on the top of the button. <ul style="list-style-type: none"> <li>• <b>ON:</b> Input auto switching function is enabled (default).</li> <li>• <b>Off:</b> Input auto switching function is disabled.</li> </ul>
3	1 VGA	<b>1 VGA Button:</b> Press to select VGA as input. <b>LED:</b> LED is located on the top of the button. <ul style="list-style-type: none"> <li>• <b>Green:</b> the input has signal and is selected.</li> <li>• <b>Yellow:</b> the input has signal but is not selected.</li> <li>• <b>Red:</b> the input has no signal but is selected.</li> <li>• <b>Off:</b> the input has no signal and is not selected.</li> </ul>
4	2 DP	<b>2 DP Button:</b> Press to select DP as input. <b>LED:</b> LED is located on the top of the button. <ul style="list-style-type: none"> <li>• <b>Green:</b> the input has signal and is selected.</li> <li>• <b>Yellow:</b> the input has signal but is not selected.</li> <li>• <b>Red:</b> the input has no signal but is selected.</li> <li>• <b>Off:</b> the input has no signal and is not selected.</li> </ul>
5	3 HDMI	<b>3 HDMI (TX) Button:</b> Press to select the HDMI IN 3 (TX) as input. <b>LED:</b> LED is located on the left of the button. <ul style="list-style-type: none"> <li>• <b>Green:</b> the input has signal and is selected.</li> <li>• <b>Yellow:</b> the input has signal but is not selected.</li> <li>• <b>Red:</b> the input has no signal but is selected.</li> <li>• <b>Off:</b> the input has no signal and is not selected.</li> </ul>
6	4 USB-C	<b>4 USB-C Button:</b> Press to select USB-C as input. <b>LED:</b> LED is located on the top of the button. <ul style="list-style-type: none"> <li>• <b>Green:</b> the input has signal and is selected.</li> <li>• <b>Yellow:</b> the input has signal but is not selected.</li> <li>• <b>Red:</b> the input has no signal but is selected.</li> <li>• <b>Off:</b> the input has no signal and is not selected.</li> </ul>
7	HDMI 1	<b>HDMI 1 (RX) Button:</b> Press to select RX HDMI IN 1 as input. <b>LED:</b> LED is located on the top of the button. <ul style="list-style-type: none"> <li>• <b>Green:</b> the input has signal and is selected.</li> <li>• <b>Yellow:</b> the input has signal but is not selected.</li> <li>• <b>Red:</b> the input has no signal but is selected.</li> <li>• <b>Off:</b> the input has no signal and is not selected.</li> </ul>

No.	Name	Description
8	HDMI 2	<p><b>HDMI 2 (RX) Button:</b> press to select RX HDMI IN 2 as input.</p> <p><b>LED:</b> LED is located on the top of the button.</p> <ul style="list-style-type: none"> <li>• <b>Green:</b> the input has signal and is selected.</li> <li>• <b>Yellow:</b> the input has signal but is not selected.</li> <li>• <b>Red:</b> the input has no signal but is selected.</li> <li>• <b>Off:</b> the input has no signal and is not selected.</li> </ul>
9	Display	<p><b>Display Control Button:</b></p> <p><b>Short press</b> - Set all the displays on.</p> <p><b>Hold press for 3s</b> - Set all the displays off.</p> <p><b>LED (Blue):</b> LED is located on the top of the button.</p> <ul style="list-style-type: none"> <li>• <b>Blinking 1 time:</b> Short Press the button, LED extinguishes after finishing the operation.</li> <li>• <b>Blinking 3 times:</b> Hold press the button for 3 seconds, LED extinguishes after finishing the operation.</li> </ul>
10	Relay 1	<p><b>Relay 1 Button:</b> Press to set the screen closed.</p> <p><b>LED (Green):</b> LED is located on the top of the button.</p> <p>Short press the button, LED blinks 1 time and extinguishes after finishing the operation.</p>
11	Relay 2	<p><b>Relay 2 Button:</b> Press to set the screen open. <b>LED (Green):</b> LED is located on the top of the button.</p> <p>Short press the button, LED blinks 1 time and extinguishes after finishing the operation.</p>

# Transmitter Rear Panel Description

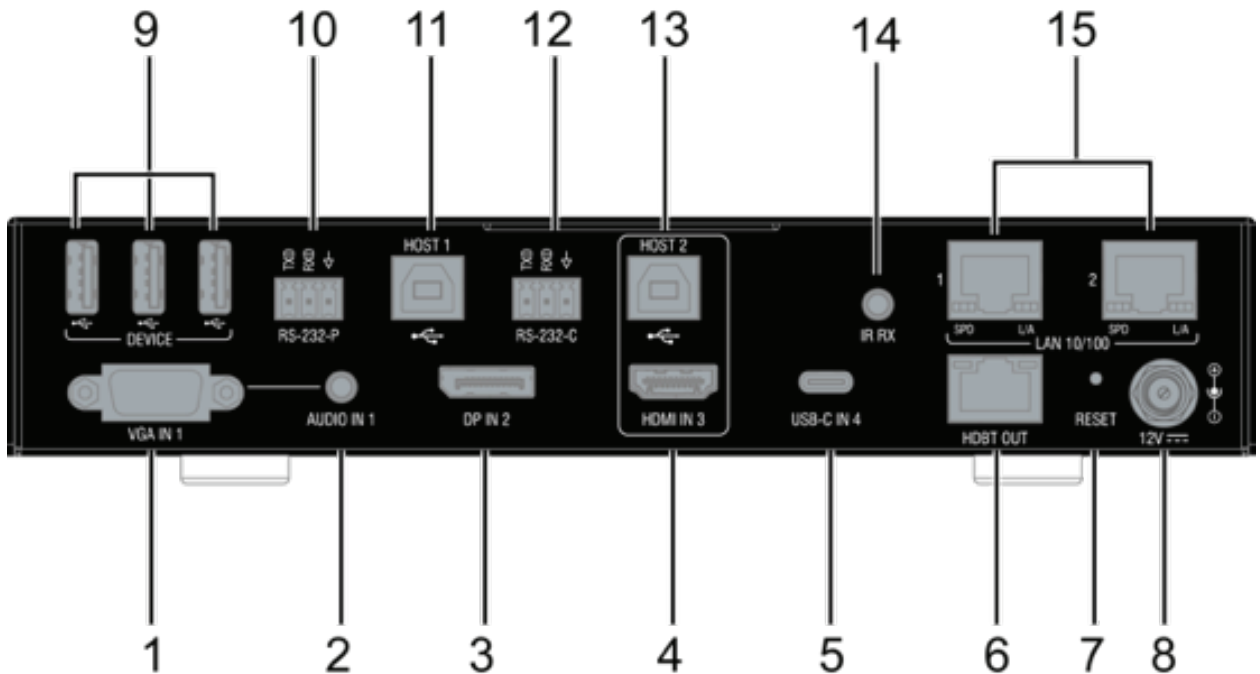

No.	Name	Description
1	VGA IN 1	Connect to the VGA source.
2	AUDIO IN 1	Audio input, embedded with the VGA source.
3	DP IN 2	Connect to the DisplayPort source.
4	HDMI IN 3	Connect to the HDMI source.
5	USB-C IN 4	Connect to the USB-C source, such as MacBook.
6	HDBT OUT	Connect to the CTC-1402 receiver via a Cat 5e/6/7 cable.
7	RESET	When the CTC-1402 TX is powered on, use a pointed stylus to hold down the RESET button for 3 seconds or more, then release, the unit will reboot and restore to its factory defaults.
8	12V	Connect to DC 12V power adapter provided.
9	DEVICE	Connect to USB devices.
10	RS232-P	Connect an RS232 device to RS232-P of TX, and a device to RS232-P of RX for RS232 pass-through.
11	Host 1	Connect to a PC which is followed with VGA IN1 and DP IN2. When the source is selected, the USB devices (on TX and RX) can be connected to a host PC.
12	RS232-C	Connect to an RS232 slave device (such as a projector). Send commands to it via NetLinX Studio.
13	Host 2	Connect to a PC which is followed with HDMI IN3. When the source is selected, USB devices (on TX and RX) can be connected to the host PC.
14	IR RX	Connect to an IR Receiver cable for passing through the IR signal to RX.
15	LAN 10/100 1-2	Connect to Ethernet devices.

# Receiver Front Panel Description

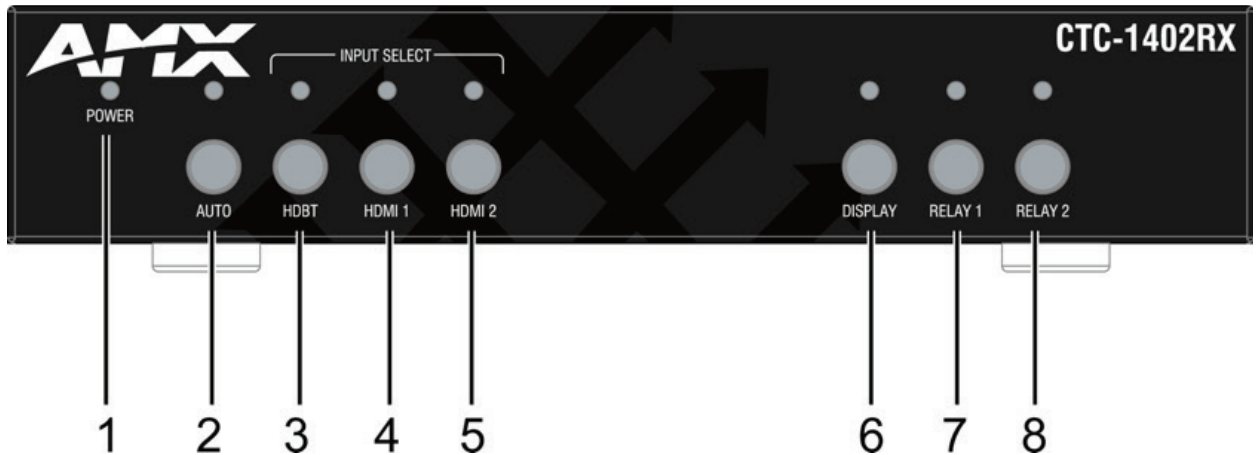

No.	Name	Description
1	POWER LED (Green)	<b>On:</b> The CTC-1402 RX is powered on. <b>Off:</b> The CTC-1402 RX is powered off.
2	Auto	<b>Auto Switch Button:</b> Press to Enable/Disable auto switching function. <b>LED:</b> LED is located on the top of the button. <ul style="list-style-type: none"> <li>• <b>ON:</b> Input auto switching function is enabled (default).</li> <li>• <b>Off:</b> Input auto switching function is disabled.</li> </ul>
3	HDBT	<b>HDBT IN button:</b> Press to select HDBT input. <b>LED:</b> LED is located on the top of the button. <ul style="list-style-type: none"> <li>• <b>Green:</b> the input has signal and is selected.</li> <li>• <b>Yellow:</b> the input has signal but is not selected.</li> <li>• <b>Red:</b> the input has no signal but is selected.</li> <li>• <b>Off:</b> the input has no signal and is not selected.</li> </ul>
4	HDMI 1	<b>HDMI 1 (RX) Button:</b> Press to select RX HDMI IN 1 as input. <b>LED:</b> LED is located on the top of the button. <ul style="list-style-type: none"> <li>• <b>Green:</b> the input has signal and is selected.</li> <li>• <b>Yellow:</b> the input has signal but is not selected.</li> <li>• <b>Red:</b> the input has no signal but is selected.</li> <li>• <b>Off:</b> the input has no signal and is not selected.</li> </ul>
5	HDMI 2	<b>HDMI 2 Button:</b> Press to select RX HDMI IN 2 source as input. <b>LED:</b> LED is located on the top of the button. <ul style="list-style-type: none"> <li>• <b>Green:</b> the input has signal and is selected.</li> <li>• <b>Yellow:</b> the input has signal but is not selected.</li> <li>• <b>Red:</b> the input has no signal but is selected.</li> <li>• <b>Off:</b> the input has no signal and is not selected.</li> </ul>
6	Display	<b>Display control Button:</b> <b>Short press</b> - Set all the displays on. <b>Hold press for 3s</b> - Set all the displays off. <b>LED (Blue):</b> LED is located on the top of the button. <ul style="list-style-type: none"> <li>• <b>Blinking 1 time:</b> Short Press the button, then LED extinguishes after finishing operation.</li> <li>• <b>Blinking 3 times:</b> Hold press the button for 3 seconds, LED extinguishes after finishing operation.</li> </ul>
7	Relay 1	<b>Relay 1 Button:</b> Press to set the screen closed. <b>LED (Green):</b> LED is located on the top of the button. Short press the button, LED blinks 1 time then extinguishes after finishing the operation.
8	Relay 2	<b>Relay 2 Button:</b> Press to set the screen open. <b>LED (Green):</b> LED is located on the top of the button. Short press the button, LED blinks 1 time and extinguishes after finishing the operation.

# Receiver Rear Panel Description

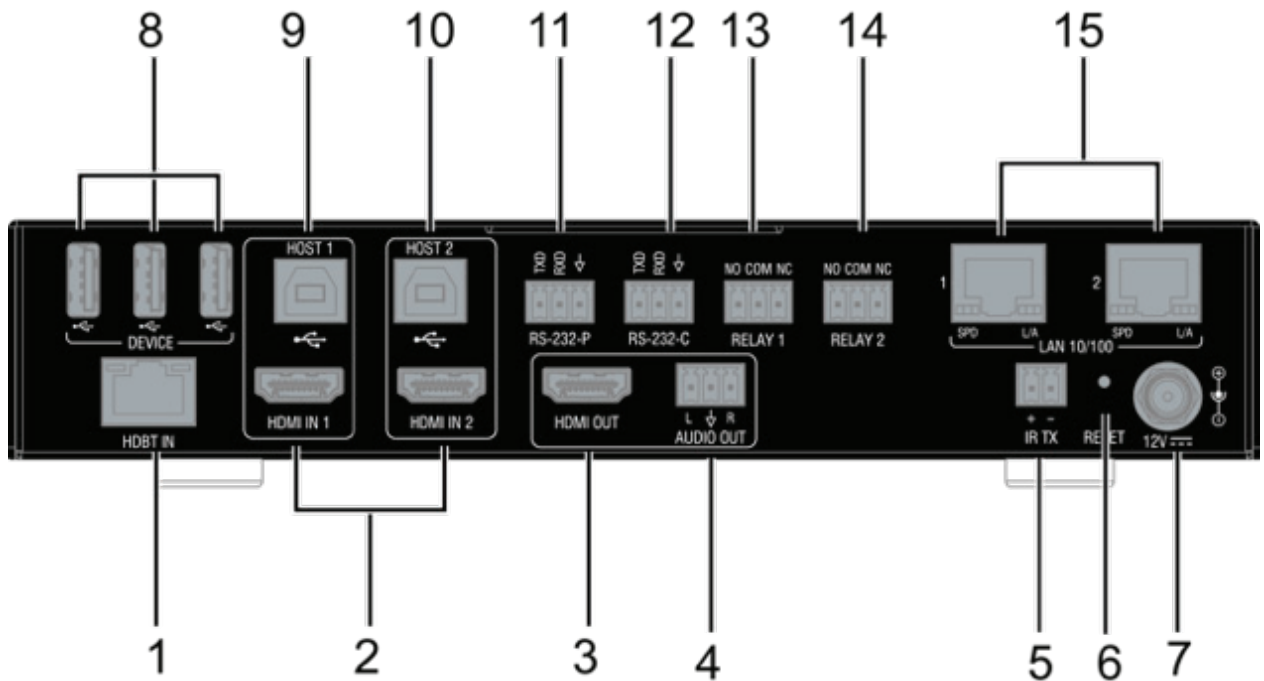

No.	Name	Description
1	HDBT IN	Connect to the CTC-1402 transmitter via a shielded Cat 6A/7 cable.
2	HDMI IN 1-2	Connect to an HDMI sources.
3	HDMI OUT	Connect to an HDMI display.
4	AUDIO OUT	Connect to the audio system with the Phoenix Connector.
5	IR TX	Connect to an IR emitter cable for emitting remote signal from TX.
6	RESET	When CTC-1402 RX is powered on, use a pointed stylus to hold down the RESET button for 3 seconds or more, then release, the unit will reboot and restore to its factory defaults.
7	12V	Connect to the provided DC 12V power adapter .
8	DEVICE	Connect to USB devices.
9	Host 1	Connect to a PC which is followed with HDMI IN1, when the source is selected. The USB devices (on TX and RX) can be connected to a host PC.
10	Host 2	Connect to a PC which is followed with HDMI IN2, when the source is selected. The USB devices (on TX and RX) can be connected to host a PC.
11	RS232-P	Connect an RS232 device to RS232-P of TX, and a device to RS232-P of RX for RS232 pass-through.
	RS232-C	Connect to an RS232 slave device (such as a projector). Send commands via NetLinx Studio.
13	Relay 1	Connect to a screen with Phoenix Connector for closing the screen.
14	Relay 2	Connect to a screen with Phoenix Connector for opening the screen.
15	LAN 10/100 1-2	Connect to Ethernet devices.

# Pinout Information

The following figures show the pinouts of the Phoenix Connectors.

## RS232

Connects to an RS232-enabled device with the 3-pole, 3.5mm captive screw connectors. Wire as shown below:

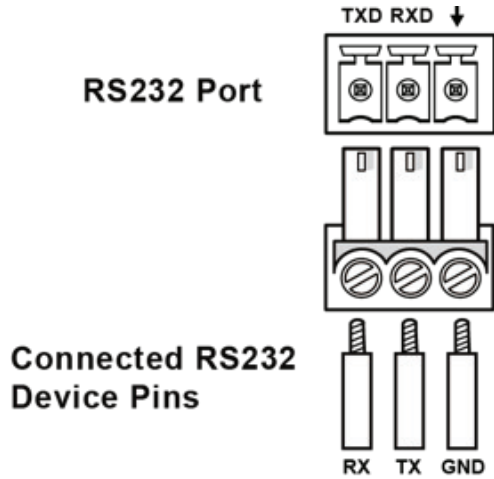

## RELAY

Connects to a projector screen with the 3-pole, 3.5mm captive screw connectors. Wire as shown below:

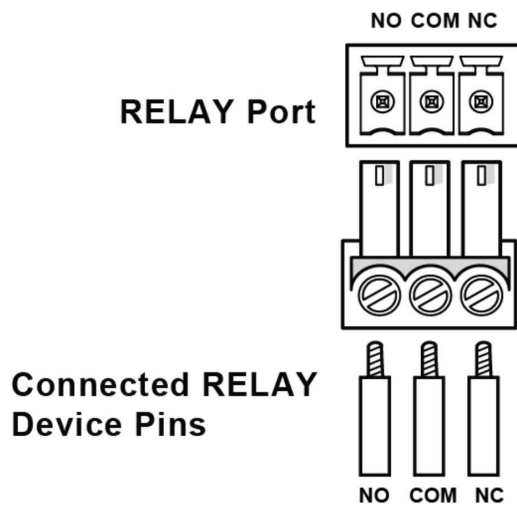

## Audio Out

Connect to an audio system, such as an amplifier, with the 3-pole, 3.5mm captive screw connector. Wire as shown below:

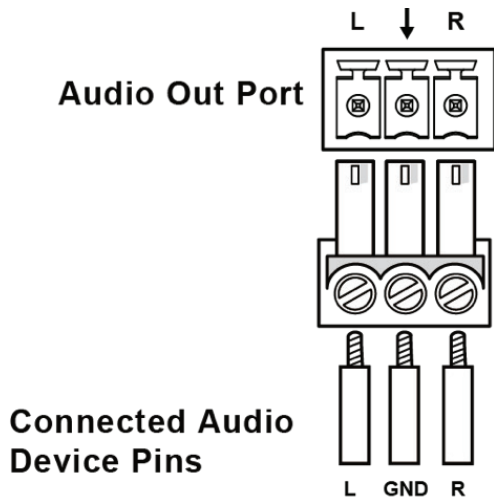



# Installation

**Warning:** Before installation, ensure the device is disconnected from the power source.

**Installation:**

1. Attach the installation bracket to the enclosure using the screws provided.  
The bracket height can be adjusted Up/Down>The bracket can face up or down.
2. The bracket is attached to the enclosure as shown.

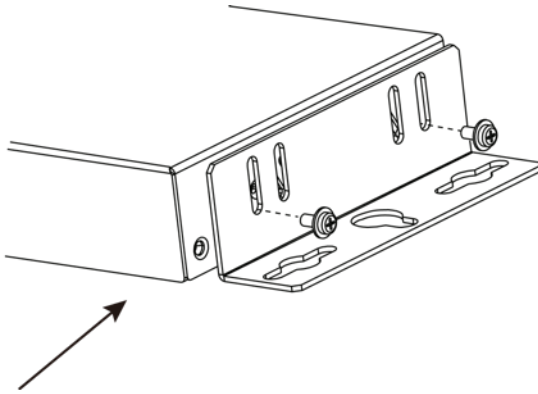

3. Repeat steps 1-2 for the other side of the unit.
4. Attach the brackets to a surface or suitable location with user supplied screws.
5. Repeat steps 1~4 to install the receiver.

# Wiring

## Warning:

- Before wiring, disconnect the power from all devices.
- Connect and disconnect the cables with care.

1. Connect input sources  
Connect HDMI/VGA/DP/USB-C sources to HDMI IN/VGA IN/DP IN/USB-C IN ports of TX or RX.

**Note:** The CTC-1402 allows users to connect BYOD wireless systems to HDMI IN as a source.

**Note:** For USB-C Video sources the use of a USB 3.0 cable with minimum transfer data rate of 5 Gbps is required. Connect the BYOD system HDMI display to the CTC-1402 HDMI IN port.

2. Connect display  
Securely connect display devices such as a TV to HDMI OUT ports of the RX, ensuring both source and display devices are compatible and correctly configured to accept the signal.
3. Connect TX and RX  
Connect a good quality, well-terminated shielded Cat 6A/7 cable with an RJ45 connector wired to the 568B standard at both ends from the HDBT OUT ports of TX to the HDBT IN ports of the RX.

**Note:** For more information regarding cabling, refer to the Cable Specification section.

4. Connect USB HOST devices.  
Connect a PC to USB HOST ports with USB cables.
5. Connect USB devices to the USB DEVICE ports of TX and RX.

Note: For more information, refer to “**USB Control**” section. USB-C is automatically recognized when the USB-C input is selected. The PC can be connected to other USB devices directly.

6. Connections additional control options:

- 1) IR

Plug the IR emitter into the IR OUT port of RX and plug the IR broadband receiver into the IR IN port of TX. Users can control the display, such as a projector, which is located at RX side with its remote.

- 2) LAN Control (Telnet/Web UI)

Connect the LAN ports to an Ethernet device such as an Ethernet switch.

- 3) RS232-P

Connect an RS232-enabled device to the RS232-P port of TX (or RX), and connect an RS232-enabled device to the RS232-P port of RX (or TX) for RS232 pass through.

- 4) RS232-C

Connect an RS232-enabled slave device (e.g. projector) to the RS232-C port, and connect the projector screen to RELAY port (1-2). Send commands to RS232-C via NetLinx Studio.

7. Connect power to the TX and RX. Power on all input sources and displays.

**Note:** When power is restored, the CTC-1402 will automatically switch to the source selected before power was restored.

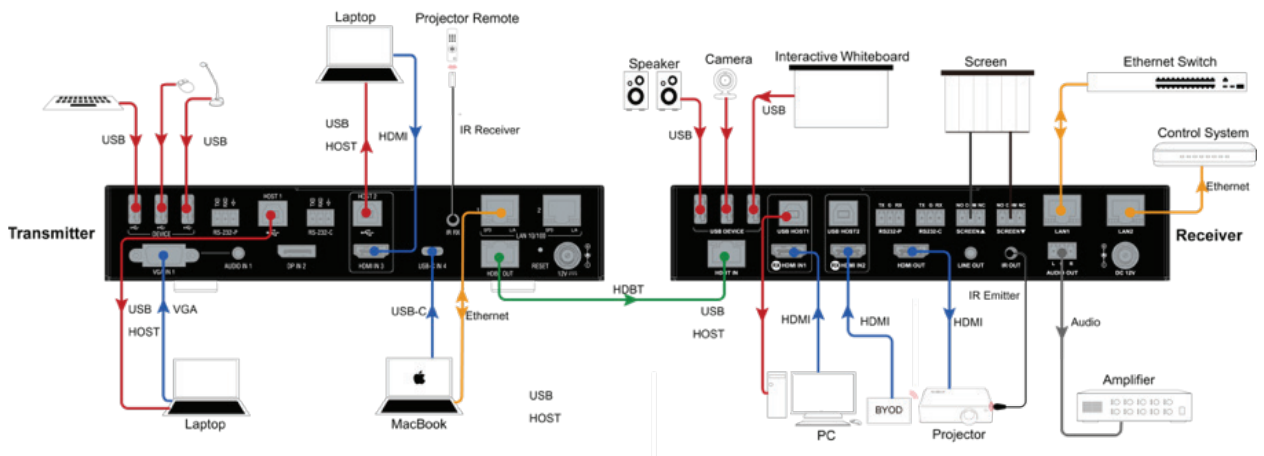

# OSD

The CTC-1402 supports OSD (On Screen Display) to convey its IP address. Follow these steps to initiate OSD:

1. Hold and Press the HDMI 1 and HDMI 2 buttons on the front panel of RX for at least 3 seconds.
2. The IP address of the CTC-1402 will display on the upper right of the connected display's screen for 15s and then disappear.

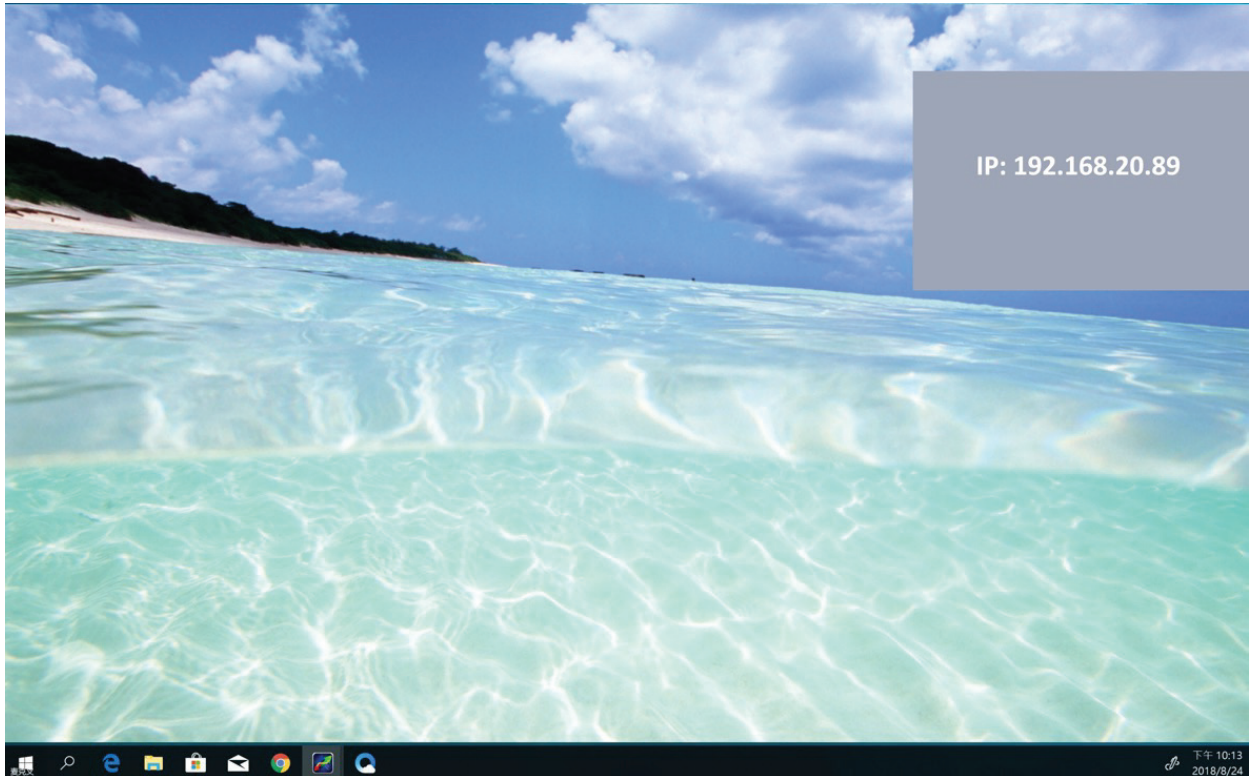

# Input Source Switching

The CTC-1402 Kit supports Auto and Manual button switching between the HDBT (HDMI, VGA) and HDMI inputs.

## Auto Switching

Press AUTO button. The Auto Switching function will be enabled immediately.

1. If more than one input ports have active signal, the priority order is VGA 1 > DP IN 2 > HDMI IN 3 > USB-C > RX HDMI IN 1 > RX HDMI IN 2;
2. New insert: LIFO (Last In-First Out);
3. New pull out: When the selected source is pulled out, the unit switches to the last selected port. If there is no active signal, the unit switches to the port with the highest priority;
4. If all input ports have no active signal, the RX HDMI IN 1 is set to active.

### Note:

- The Auto Switching function is enabled by default once all devices are powered on.
- Auto Switching can be set to Enabled or Disabled through NetLinX Studio and the front panel button.
- Power-off protection: When Auto Switching or Manual Switching are selected before powering off, the device will remain in the same mode after powering back on. When Auto Switching is selected before powering off, and the previously selected port has active signal after powering the device back on, the port will remain selected. If the port is not active, and more than one input ports have active signal, Auto Switching will follow priority order.

## Manual Switching

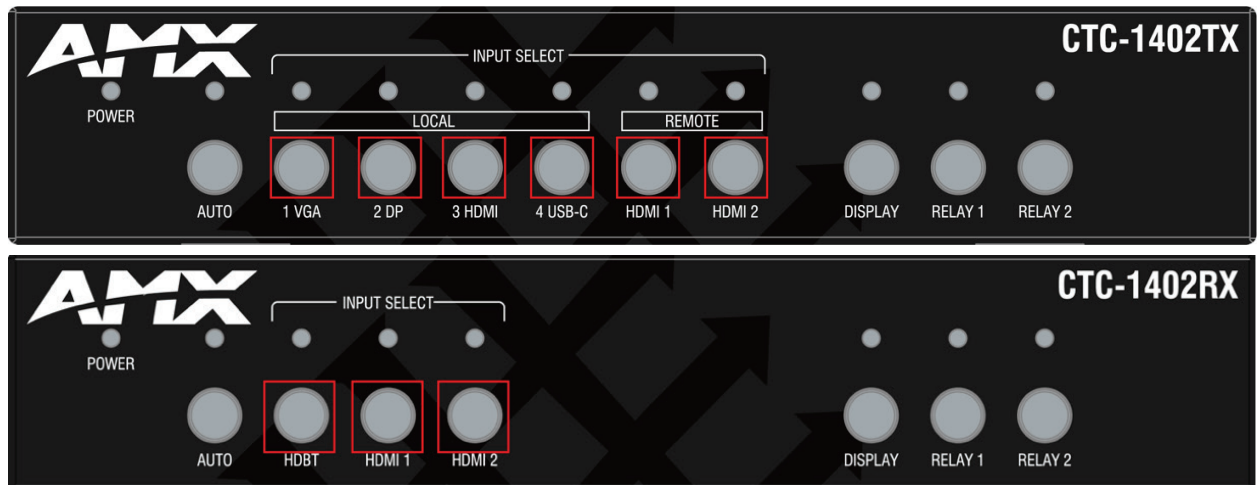

Press the AUTO Button (ensure AUTO LED is off) or the specific input button (in red frames above) to enable Manual Switching. In Manual Switching mode:

1. When the input port with no source is selected, CTC-1402 will output no signal;
2. If the Power is cycled, on the CTC-1402, the Manual Switching function will remain enabled.

### Note:

- Manual Switching is also available when Auto Switching is on, but will only apply to active input sources.
- Manual Switching will remain available when Auto Switching is off, and can switch among inactive input ports.

# USB Control

Please connect your PC and other USB devices before operation.

- Connect a PC to the USB HOST ports with USB cables.
- Connect USB devices to the USB DEVICE ports of TX and RX.

Combining the above two steps--The PC will be followed by the source port which is under the USB HOST port. When the source in the same group is selected, the USB devices (on TX and RX) can be connected to the host PC.

Please refer to the following diagrams.

**Note:** USB-C is built into USB 2.0, so when the USB-C input is selected, the PC can be connected directly to other USB devices.

1. VGA / DP source on TX is selected:

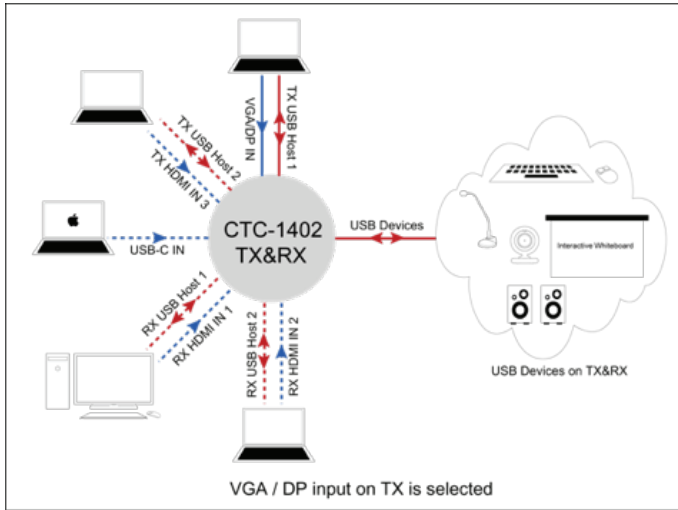

VGA IN 1, AUDIO IN 1 and HOST 1 are in a group, DP IN 2 and HOST 1 is in a group. Only if the VGA or DP is selected, the USB devices can be connected to the PC which is connected to USB HOST 1.

2. HDMI IN 3 source on TX is selected:

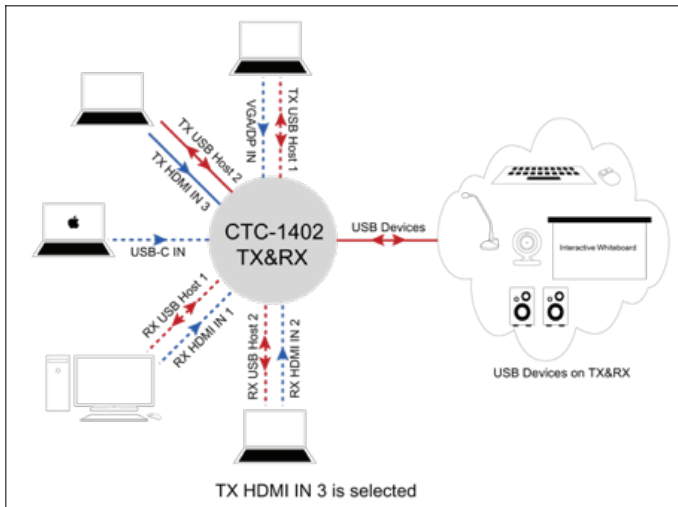

TX HDMI IN 3 and TX HOST 2 is in a group.

Only when HDMI IN 3 is selected, USB devices can be connected to the PC which is connected to USB HOST 2.

3. USB-C source on TX is selected:

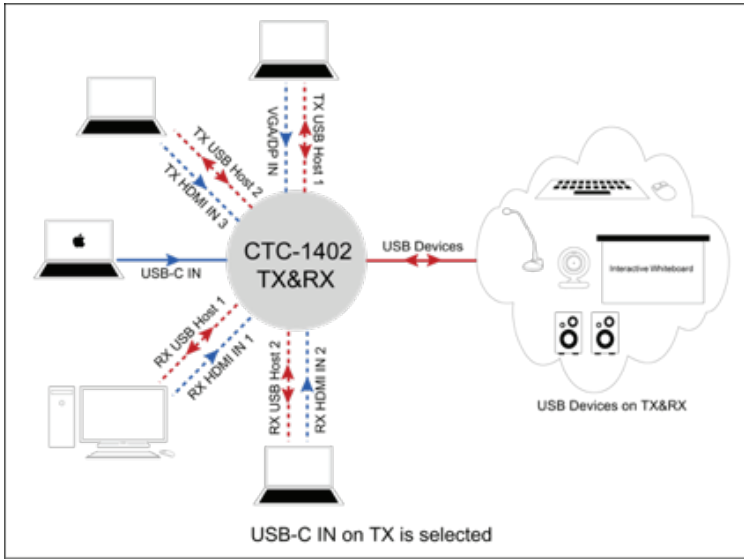

When the USB-C input is selected, the USB devices can be connected to the PC directly.

4. HDMI IN 1 on RX is selected:

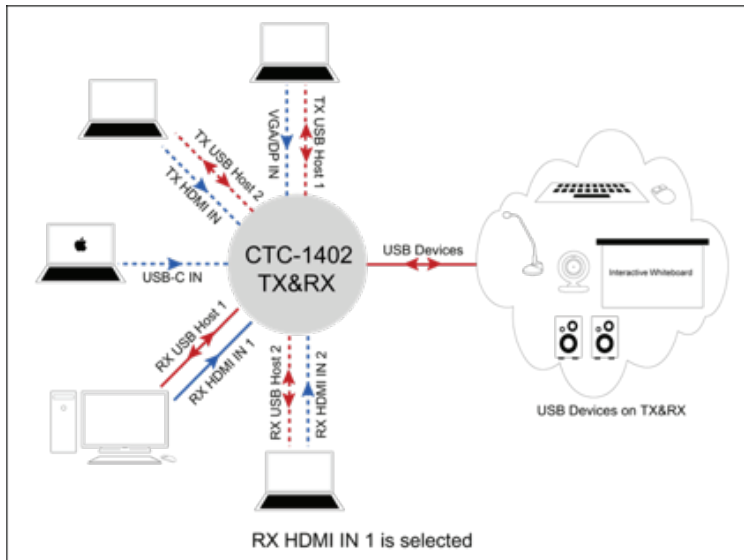

RX HDMI IN 1 and RX HOST 1 are in a group. Only if the RX HDMI IN1 is selected, the USB devices can be connected to the PC which is connected to RX USB HOST 1.

- HDMI IN 2 on RX is selected:

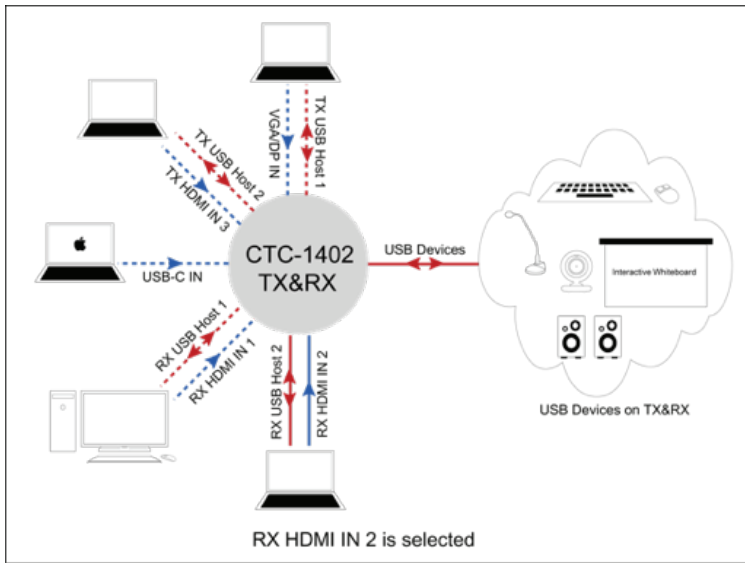

RX HDMI IN 2 and RX HOST 2 are in a group. Only if the RX HDMI IN 2 is selected, the USB devices can be connected to the PC which is connected to RX USB HOST 2.

The CTC-1402 kit supports 1 external USB Hub connected to either the TX or RX Device Port. Devices which present themselves as USB hub such as AMX Acendo Vibe will count as 1 external USB Hub. USB Device Ports support power to connected devices not to exceed .5A per USB device port.

# NetLinx Studio Control

Controlling the CTC-1402 through NetLinx studio via Ethernet port.

## Device Number and Ports

The physical ports of the product can be mapped to NetLinx studio as follows:

### **Transmitter:**

Port 1: RS-232-P

Port 2: RS-232-C

Port 4: IR RX

Port 5: USB Device

Port 6: DP IN 2

Port 7: VGA IN 1, Audio IN 1

Port 8: HDMI IN 3

Port 9: USB-C IN 4

Port 10: USB Host 1

Port 11: USB Host 2

### **Receiver:**

Port 21: RS-232-P

Port 22: RS-232-C

Port 24: IR IN

Port 25: USB Device

Port 26: HDMI OUT, Audio Out-P, Auto Out (de-embedding)

Port 27: HDMI IN 1

Port 28: HDMI IN 2

Port 30: USB Host 1

Port 31: USB Host 2

Port 12: Relays 1-2



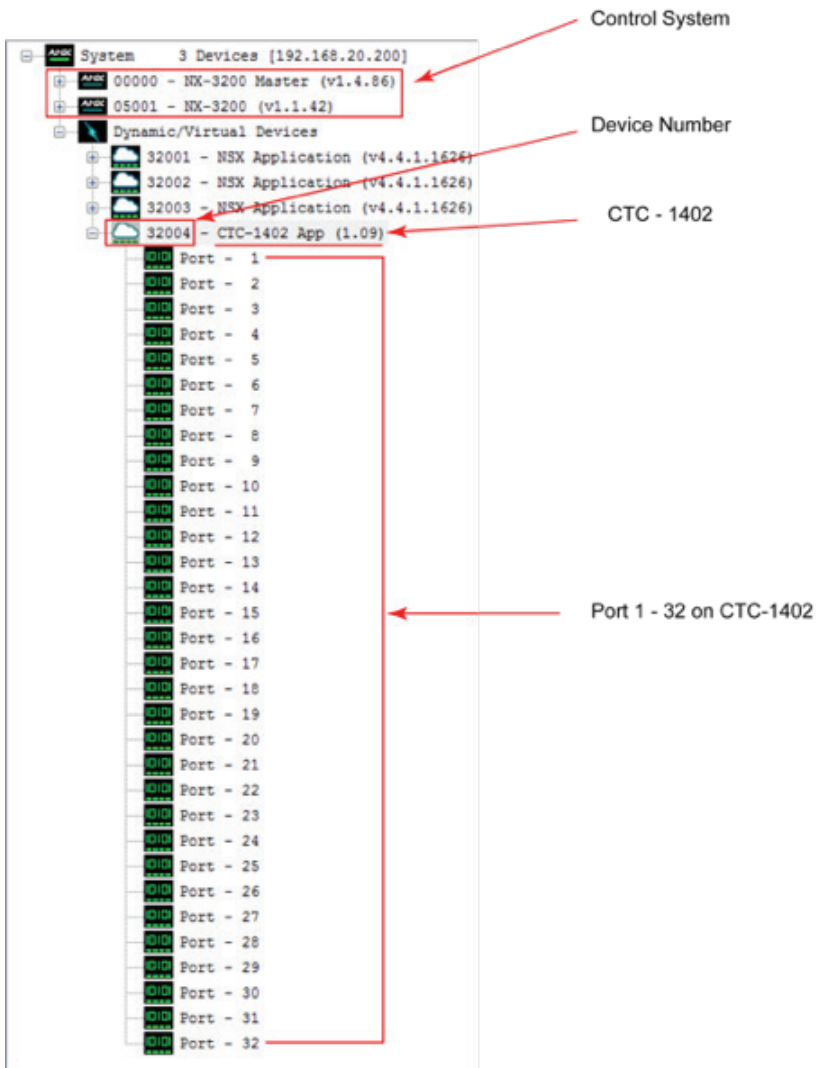

After configuring each port respectively, control commands can be sent to the device.

## Send Commands to Control a Device

Click “Diagnostics” on the menu bar, choose “Control a Device”.

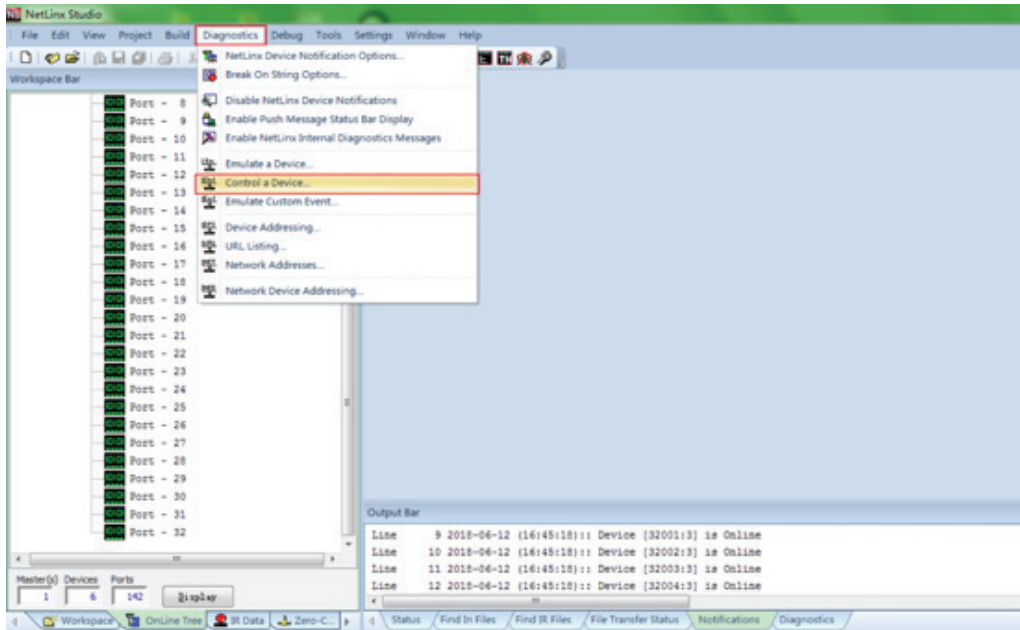

A window will display as follows, enter a command in the textbox, and click “Send To Device”. (For API commands, see the **Section API Command Set**.)

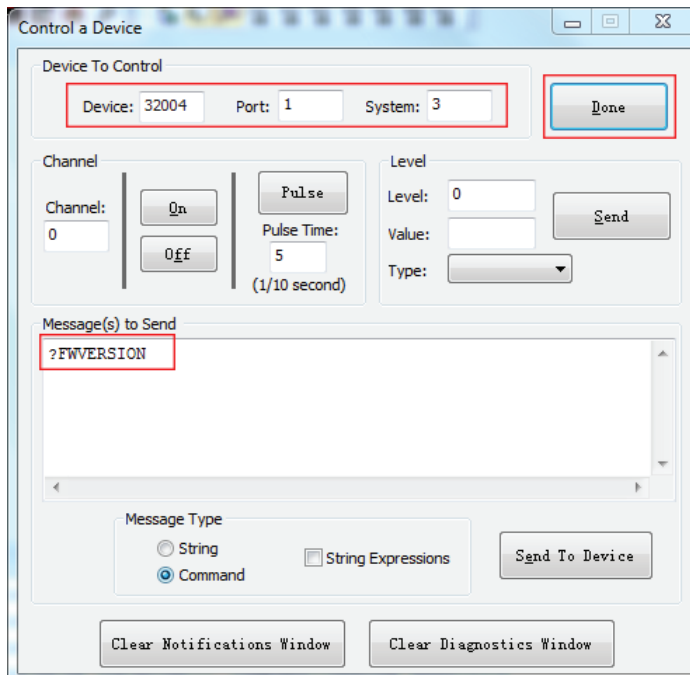

## Telnet Control via NetLinX Studio

1. Choose the device you want to control, right click, then choose **TELNET Window->Launch TELNET window via NetLinX Studio**, enter the Telnet window, input the Telnet API in this window to control the device.

**Note:** For API Commands, see the section **API Command Set**

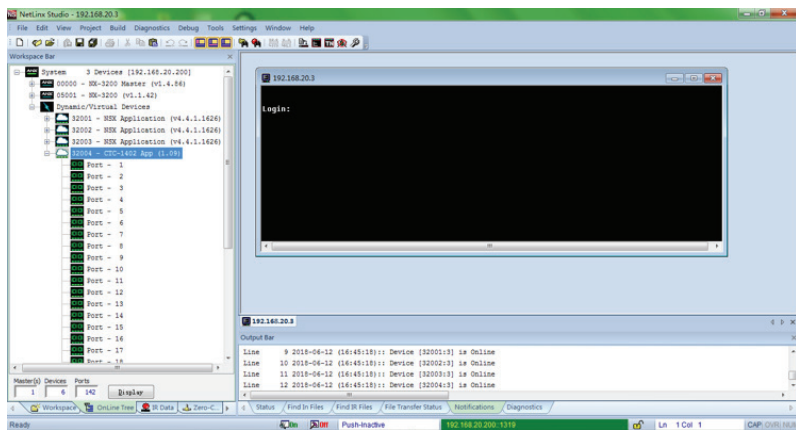
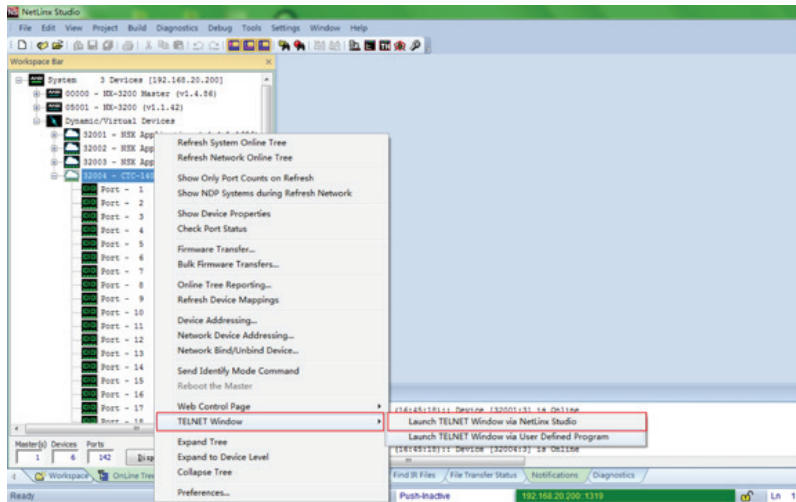

2. At the prompt (>), type the Telnet command and press Enter.

If “Launch TELNET Window via User Defined Program” is selected, it may be require to enable Telnet as follows:

1. Go to Start/Control Panel/Programs and Features;
2. On the left, select “Turn Windows features On or Off”;
3. Select the check-boxes Telnet Client and Telnet Server, and click “OK”.

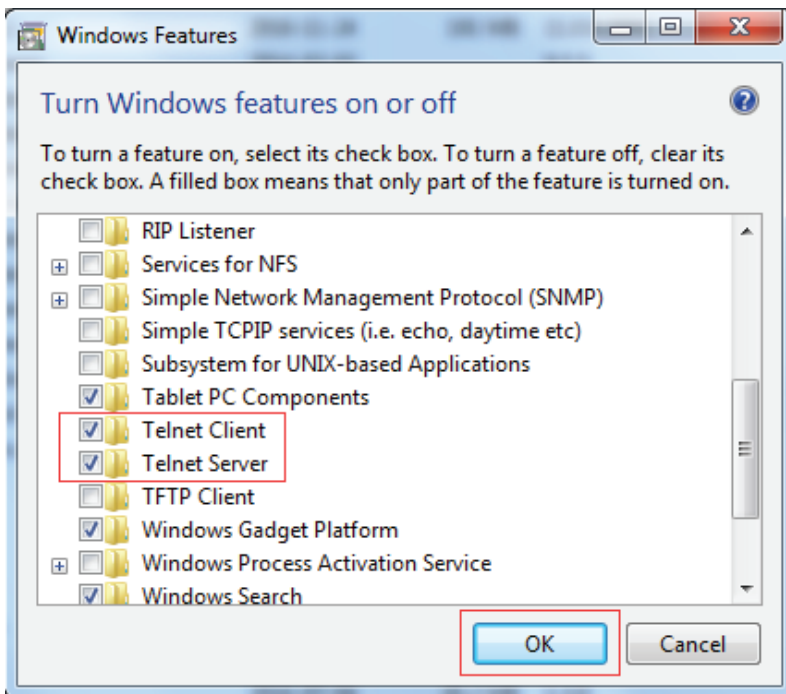

## Web UI Control

Choose the device to be controlled, right click, then choose **Web Control Page->Launch Web Control Page via Default Browser**, enter the Web UI Control Page.

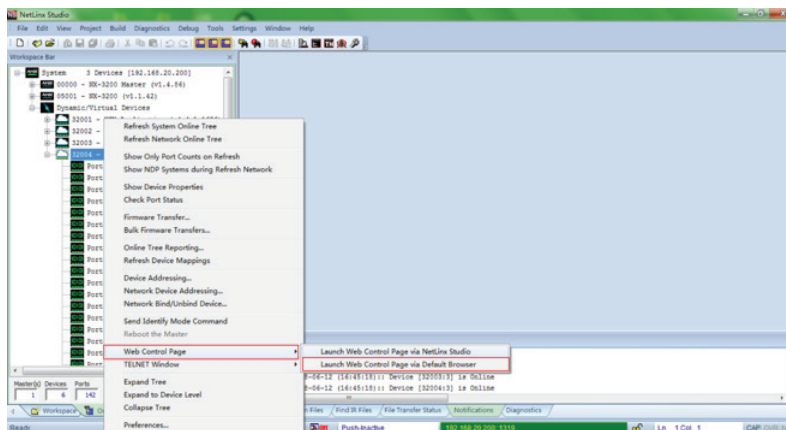

# Web UI Control

The Web UI designed for the CTC-1402 allows basic controls and advanced settings of the device. The Web UI page can be accessed through NetLinx Studio.

## Access the Web Interface

To get access to Web UI:

1. Connect your PC and the LAN port of the CTC-1402 to the same local area network.
2. In NetLinx Studio's Online Tree, select "**Web Control Page**" > "**Launch Web Control Page via NetLinx Studio**" (or select "**Launch Web Control Page via Default Browser**"). Entering the IP address in the web page will also enter the web interface.

The following page will pop up. Enter the default password "admin" and click "Login".

### CTC-1402 Control

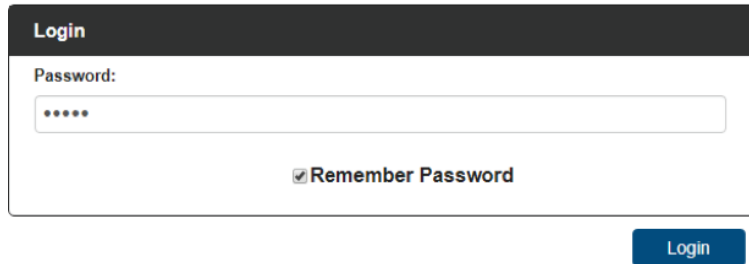

The login form is titled "Login" and features a "Password:" label above a text input field containing six dots. Below the input field is a checkbox labeled "Remember Password". A blue "Login" button is positioned to the right of the form.

After logging in, the following interface appears:

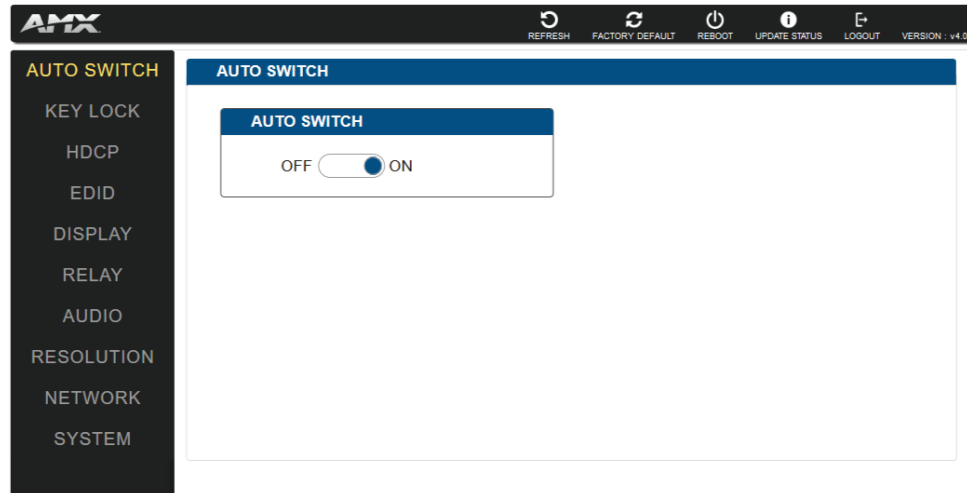

## Web Interface Introduction

The Interface includes 9 submenus:

- AUTO SWITCH
- KEY LOCK
- HDCP
- EDID
- DISPLAY
- RELAY
- AUDIO VOLUME
- RESOLUTION
- NETWORK
- SYSTEM

The top of the interface includes REFRESH, FACTORY DEFAULT, REBOOT, UPGRADE STATUS and Firmware VERSION.



### Refresh



Click **REFRESH** to refresh the status of device in the Web UI interface.

### Factory Default



Click **FACTORY DEFAULT** to set the device to factory default. Click the button, a window pops up.

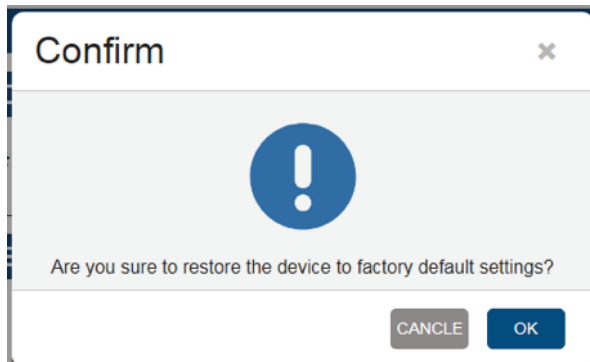

Click **OK** to take effect.

### Reboot



Click **REBOOT** to reboot the device. Click the button, a window pops up.

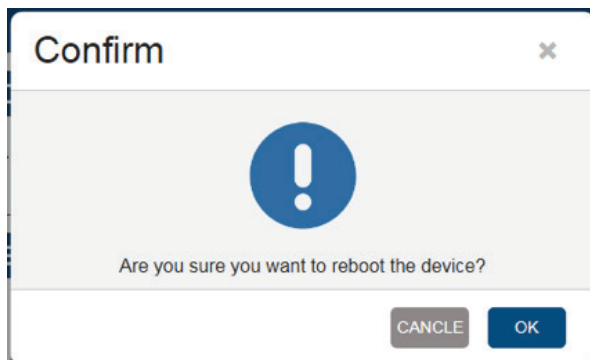

Click **OK** to take effect.

## Upgrade Status

To upgrade the firmware of the device, click , to check the upgrade status.

## LOGOUT

Click , to return to the **Login** page.

## Firmware VERSION

Click  to check the current firmware version.

## Auto Switch:

Users can enable or disable the Auto Switch function in this column. Auto Switch ON is the default. For more information, refer to the Input Source Switching section.

When set to OFF, switching the source can only be Manual.

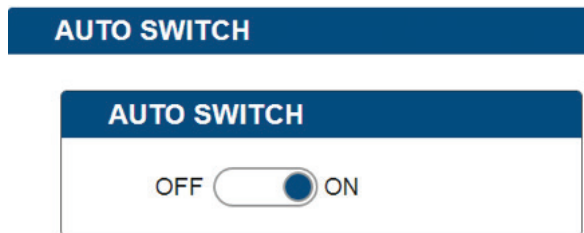

## Key Lock

In this column, users can set the key lock On/Off.

- **ON:** The panel buttons are disabled for switching the sources and displays.
- **OFF:** The panel buttons are active for switching the sources and displays.

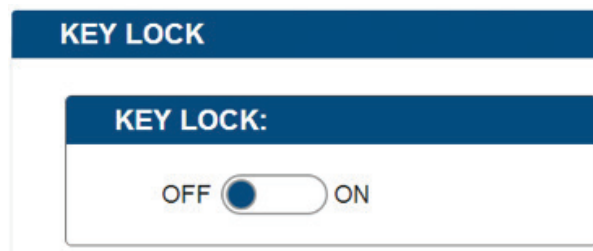

## HDCP

In this column, users can Enable/Disable the HDCP of TX HDMI, USB-C, RX HDMI 1, and RX HDMI 2 ports.

- **ON:** Input ports support HDCP.
- **OFF:** Input ports do not support HDCP.

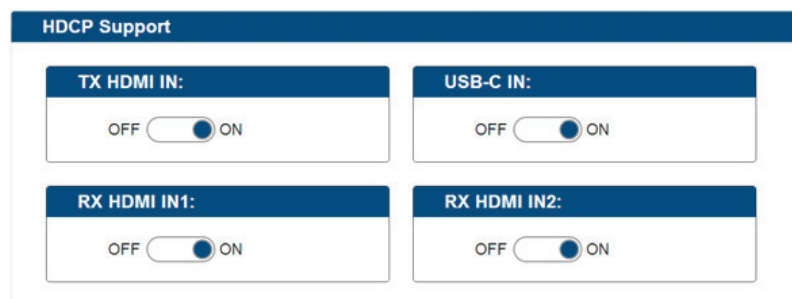

## EDID

In this column, the input EDID can be set to system requirements. Click the drop-down menu to select resolution, click **Apply** to take effect.

**EDID SUPPORT**

<b>VGA</b> 1920x1080@60Hz 2CH (Default) <input type="button" value="APPLY"/>	<b>DP</b> Copy from output (Default) <input type="button" value="APPLY"/>
<b>TX HDMI IN</b> Copy from output (Default) <input type="button" value="APPLY"/>	<b>USB-C</b> Copy from output (Default) <input type="button" value="APPLY"/>
<b>RX HDMI IN1</b> Copy from output (Default) <input type="button" value="APPLY"/>	<b>RX HDMI IN2</b> Copy from output (Default) <input type="button" value="APPLY"/>

## Display

In this column, control of the displays is available.

### Auto Display Control

**ON:** Click to enable Auto Display Control.

**DELAY TIME (1~30 min):** Click the down arrow to set the time for the display to power off automatically when no signal is present. Example: With the time set to 2 minutes, the output display will be powered off automatically when there is no signal input for 2 minutes.

**OFF:** Click to disable the Auto Display Control. (Default setting)

**DISPLAY**

**AUTO DISPLAY CONTROL**

OFF  ON      DELAY TIME(1-30 min): 2 min

## RS232 Setting

In this column, users can select the RS232 control mode.

- **CONTROL:** Slide the button to select RS232 control mode.  
**Local** (default): Local sending of commands to control the projector.  
**Netlinx:** Sending commands via NetLinx studio to control the projector.
- **DEVICE:** When "Netlinx" is selected, click the down arrow to select TX or RX for RS232 setting.
- **BAUD RATE:** Click the down arrow to select the baud rate.
- **PARTY BITS:** Click the down arrow to select the parity bits.
- **DATA BITS:** Click the down arrow to select the data bits.
- **STOPS BITS:** Click the down arrow to select the stop bits.
- **END FLAG:** Select the ending flag after each RS232 command.
- **POWER ON:** Enter the RS232 command to turn on the projector and screen, then click the "**SAVE**" button to take effect.
- **POWER OFF:** Enter the RS232 command to turn off the projector and screen, then click the "**SAVE**" button to take effect.
- **APPLY:** Click "**APPLY**" to take effect.



**RS232 SETTING**

CONTROL: Local  Netlinx

BAUD RATE: 9600

PARITY BITS: NONE

DATA BITS: 8

STOP BITS: 1

END FLAG: None r \n r\n

POWER ON:

POWER OFF:

**RS232 SETTING**

CONTROL: Local  Netlinx

DEVICE: please select

BAUD RATE: please select



PARITY BITS: please select

DATA BITS: 8

STOP BITS: please select

## Relay

In this column, users are able to set Relay On/Off and the Relay Mode: Latch or Momentary.

**RELAY CONTROLLER:** Click  to raise the projector screen, and click  to drop the projector screen down.

**Latch:** Level triggered.

**RELAY CONTROLLER**

RELAY :  

**RELAY MODE**

LATCH

**Momentary:** Pulse triggered. The delay time can be set (1~10 seconds).

**RELAY CONTROLLER**

RELAY :  

**RELAY MODE**

MOMENTARY

**MOMENTARY TIME**

3 s (1-10 seconds)

## Audio Volume

**Output Volume:** Move the slider to set the output audio volume.

**Max/Min:** Move the sliders at the left and right sides of the scale to set the maximum and minimum range of the audio volume.

**Mute:** Click to mute the audio.

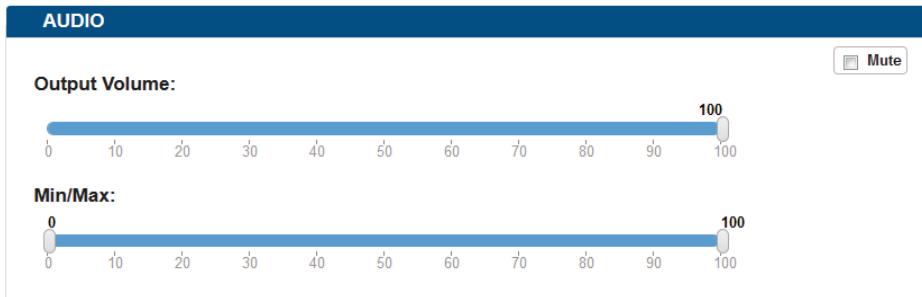

## Resolution

In this column, users are able to set Output resolution AUTO or MANUAL. AUTO is default.

**AUTO:** Output resolution is automatically set..

**MANUAL:** Click to set the output resolution to Manual mode. In Manual mode, click the down arrow to select a specific output resolution as required.

**APPLY:** Click to set the output resolution to the desired setting.

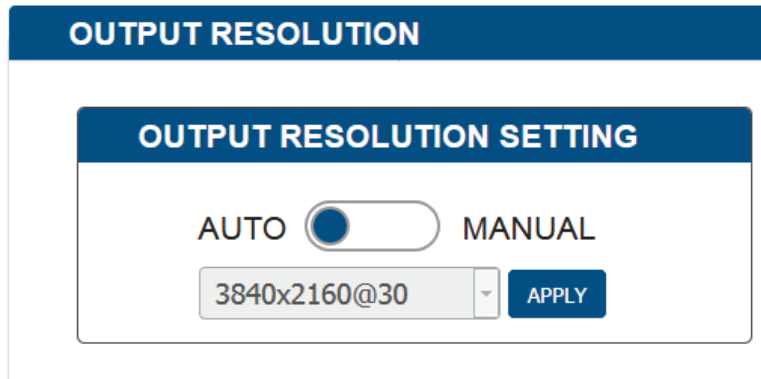

## Network

Device IP Mode:

- **DHCP:** When enabled, the IP address of the CTC-1402 will be assigned automatically by the connected DHCP server.
- **Static:** When the CTC-1402 fails to obtain or detect an IP address from the network it is connected to, select “**Static**” to set up the IP address manually.
- **APPLY:** Click to initiate the network setting.

### NETWORK

<b>DEVICE IP MODE</b> <input type="radio"/> DHCP <input checked="" type="radio"/> STATIC	<b>MAC ADDRESS</b> 00:60:9F:A4:5f:90
<b>DEVICE IP ADDRESS</b> 192.168.20.89	<b>IP HOSTNAME</b> AMX-awefrereqr
<b>SUBNET MASK</b> 255.255.255.0	<b>DNS 1</b> 192.168.1.10
<b>DEFAULT GATEWAY</b> 192.168.20.1	<b>DNS 2</b> 8.8.8.80

**APPLY**

NOTE: LAN MODULE WILL AUTOMATICALLY REBOOT AFTER CHANGING NETWORK SETTING.

**Note:** Wait 2-3 minutes for the device's LAN module to reboot and reconnect after the network setting is changed.

## System

The system section is used to set the ICSP Parameter, Login Password, Telnet/SSH On/Off, Telnet Account and SSH Account.

### ICSP Parameter

In this column, the ICSP parameter can be set. Click “APPLY” for the settings to take effect.

- **CONNECTION MODE:** includes four options: NDP, Auto IP, URL/TCP, URL/UDP. The default setting is NDP.
- **MASTER URL:** Input the connected master’s URL.
- **SYSTEM NUMBER:** Use the Online Tree to determine the system number. By default, it is disabled to be configured.
- **DEVICE NUMBER:** Use the Online Tree to determine the device number. By default, it is disabled to be configured.

Click “APPLY” for the settings to take effect.

### Login Password

In this column, the Login Password can be changed. Input the old password in “OLD PASSWORD” box. Input the new password in “NEW PASSWORD” box. Click “APPLY” for the settings take effect.

## TELNET/SSH Access

In this column, the TELNET/SSH connection can be turned On/Off.  
The default setting is "ON".

**TELNET/SSH ACCESS**

TELNET: OFF  ON

SSH: OFF  ON

Click "APPLY" for the settings to take effect.

**Note:** The device must be rebooted for the setting to take effect.

## TELNET Account

Telnet Account is used to configure the user name and password of the account.  
The default user name and password are null.

**APPLY:** Click to execute the setting.

**TELNET ACCOUNT**

USERNAME:

PASSWORD:

## SSH Account

SSH Account is used to configure the user name and password of the account.  
For SSH Account, the default user name is **admin**, the default password is **password**.

**Note:** Reboot the device for setting changes to take effect.

**APPLY:** Click "APPLY", for reboot to take effect.

**SSH ACCOUNT**

USERNAME:

PASSWORD:

# Firmware Upgrade

The CTC-1402 uses KIT files for firmware upgrade.

## Before Starting

1. Verify that you have the latest version of NetLinx Studio on your PC.
2. Download the latest firmware (KIT) file to your PC. (Place KIT files on a local drive for the fastest throughput.)
3. Verify the following:
  - a) Verify that an Ethernet/RJ-45 cable is connected from CTC-1402 to the same network as the control system.
  - b) Verify the CTC-1402 unit is powered ON.
4. Launch NetLinx Studio and open the Online Tree.
5. Bind the target device to the integrated Master: select and right-click the CTC-1402: from the context sensitive menu, select **"Network Bind/Unbind Device"** (be sure the check box is selected), click **"OK"**.
6. Launch Web UI page before upgrading the firmware to determine the current upgrade status. For more information, refer to **"UPGRADE STATUS"** in the Web UI Control section.

## Transferring KIT Files

### **Important Upgrade Information:**

Upgrading the firmware is a serious action in that if the upgrade fails, it can leave the system completely non-operational. Please ensure no power-off during the upgrade process.

## Transferring KIT Files

The system will be non-operational during the upgrade procedure below.

1. In NetLinx Studio from the **Tools** menu, select **"Firmware Transfers > Send to NetLinx Device"**, select **"Stop Communications"** in the following box, and then enter the **Send to NetLinx Device** dialog box.

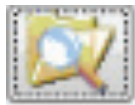

2. Click to navigate to the target directory. The selected directory path is displayed in the Location text box. KIT files in the target directory display under File Name.
3. Select the appropriate KIT file from the File Name list.
4. Enter the Device and System numbers (see **Device Number and Ports** part of **NetLinx Programming** section) for the target module in the Device and System text boxes.
  - The number of NetLinx Master is 3.
  - The Device number assigned to the integrated control ports is 32004.

**Note:** Use the **Online Device Tree** to determine if the device's assigned IDs have been changed.

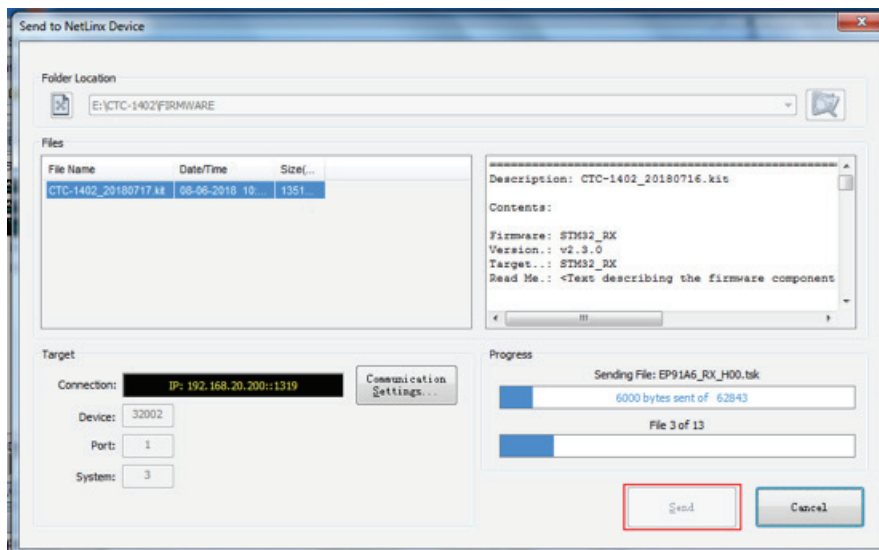

5. Click **“Send”** to send the file to NetLinX Master and upgrade the firmware on the CTC-1402.
6. Click  web UI to check progress of the firmware upgrade.
7. The device will restart automatically. Do not power cycle.

**Note:**

- The upgrade process will last 1 hour.
- Do not power off the Device until the upgrade has been successfully completed.
- The device will restart two times to resume normal operation.

# Troubleshooting

1. **Power:** Ensure all devices are powered on.
2. **Indicator:** Ensure all LED indicators of the CTC-1402 are normal according to the user manual.
3. **Devices:** Ensure picture can be shown normally when directly connecting a source a display device.
4. **Cable:** Plug the HDMI/Cat X cable in and out or connect a different HDMI/Cat X cable. Ensure the specific cable length is within the available transmission range according to the Specifications Section.
5. **Compatibility:** Test other source and display devices to determine correct compatibility.



# API Command Set

## Device Port Name and Port Number:

Model name		Port name	Port No.
CTC-1402	TX	VGA IN1 (Audio in1)	7
		DP IN2	6
		HDMI IN3	8
		USB-C IN4	9
		HOST 1	10
		HOST2	11
		USB device	5
		RS-232C	2
		RS-232P	1
		Audio in-p	7
		IR RX	4
		HDBT OUT	
		RX	HDBT IN
	HDMI IN1		27
	HDMI IN2		28
	HDMI OUT		26
	Audio out(de-embedding)		26
	HOST1		30
	HOST2		31
	RELAY1		32
	RELAY2		32
	IR IN		24
	USB device	25	
Audio out-p	26		
RS232-C	22		
RS232-P	21		

## NetLinx Commands

No.	Function Description	Syntax	Example
1	VIDIN_AUTO_SELECT To set the Auto Switch On/Off	<b>Command:</b> SEND_COMMAND <DEV>,"VIDIN_AUTO_SELECT-<ENABLE DISABLE>"  <b>Return:</b> VIDIN_AUTO_SELECT-<ENABLE DISABLE>	<b>Command:</b> SEND_COMMAND <DEV>,"VIDIN_AUTO_SELECT-DISABLE"  <b>Return:</b> VIDIN_AUTO_SELECT-DISABLE  <b>Description:</b> Set Auto Switch Status off
2	?VIDIN_AUTO_SELECT To verify the Auto Switch Status	<b>Command:</b> SEND_COMMAND <DEV>,"?VIDIN_AUTO_SELECT"  <b>Return:</b> VIDIN_AUTO_SELECT-<ENABLE DISABLE>	<b>Command:</b> SEND_COMMAND SWITCHER,"?VIDIN_AUTO_SELECT"  <b>Return:</b> VIDIN_AUTO_SELECT-ENABLE  <b>Description:</b> Get Auto Switch Status. The Auto Switch Status is on.
3	FP_LOCKOUT To set Key Lock On/Off	<b>Command:</b> SEND_COMMAND <DEV>,"FP_LOCKOUT-<ENABLE DISABLE>"  <b>Return:</b> FP_LOCKOUT-<ENABLE DISABLE>	<b>Command:</b> SEND_COMMAND <DEV>,"FP_LOCKOUT-DISABLE"  <b>Return:</b> FP_LOCKOUT-DISABLE  <b>Description:</b> Set Key Lock off
4	?FP_LOCKOUT To verify the Key Lock Status	<b>Command:</b> SEND_COMMAND <DEV>,"?FP_LOCKOUT"  <b>Return:</b> FP_LOCKOUT-<ENABLE DISABLE>	<b>Command:</b> SEND_COMMAND SWITCHER,"?FP_LOCKOUT"  <b>Return:</b> FP_LOCKOUT-ENABLE  <b>Description:</b> Get Key Lock status. The Key Lock status is on.
5	CI<input>O<output> To execute a switch	<b>Command:</b> SEND_COMMAND <DEV>,"CI<input>O<output>"  <b>Return:</b> SWITCH-I#,OALL  <b>Description:</b> I#: #={1 ~ 7} //{ 1: VGA- IN; 2: DP_IN; 3: TX_HDMI_IN; 4: USB-C_IN; 5: RX_HDBT_IN; 6: RX_HDMI_IN1; 7: RX_HDMI_IN2; } <output> {ALL}	<b>Command:</b> SEND_COMMAND SWITCHER,"CI2OALL"  <b>Return:</b> SWITCH-I2,OALL  <b>Description:</b> Switches HDMI IN1 to Outputs

## NetLinx Commands (cont.)

No.	Function Description	Syntax	Example
6	?INPUT To verify switch status	<p><b>Command:</b> SEND_COMMAND &lt;DEV&gt;, ""?INPUT""</p> <p><b>Return:</b> SWITCH-L&lt;sl&gt;I&lt;input&gt;O&lt;output&gt;</p> <p><b>Description:</b> &lt;sl&gt; : {ALL}. &lt;input&gt; //{ 1: VGA- IN; 2: DP_IN; 3: TX_HDMI_IN; 4: USB-C_IN; 5: RX_HDBT_IN; 6: RX_HDMI_IN1; 7: RX_HDMI_IN2; } &lt;output&gt; {ALL}</p>	<p><b>Command:</b> SEND_COMMAND SWITCHER, ""?INPUT""</p> <p><b>Return:</b> SWITCH-ALL,I1,OALL.</p> <p><b>Description:</b> HDMI IN1 to All Outputs</p>
7	?VIDIN_STATUS To verify Input signal status	<p><b>Command:</b> SEND_COMMAND &lt;DEV&gt;,""?VIDIN_STATUS""</p> <p><b>Return:</b> VIDIN_STATUS-&lt;status string&gt;</p> <p><b>Description:</b> input port: { VGA IN; HDMI IN1; HDMI IN2; HDMI IN3; }  &lt;status string&gt; { NO SIGNAL; VALID SIGNAL; }</p>	<p><b>Command:</b> SEND_COMMAND VIDEO_INPUT_1,""?VIDIN_STATUS""</p> <p><b>Return:</b> VIDIN_STATUS-NO SIGNAL</p> <p><b>Description:</b> VGA IN Input no signal.</p>
8	CEC_DISP_POWER To execute a display control on/off	<p><b>Command:</b> SEND_COMMAND &lt;DEV&gt;,"CEC_DISP_POWER-&lt;ON OFF&gt;""</p> <p><b>Return:</b> CEC_DISP_POWER-&lt;ON OFF&gt;</p>	<p><b>Command:</b> SEND_COMMAND &lt;DEV&gt;,"CEC_DISP_POWER-OFF""</p> <p><b>Return:</b> CEC_DISP_POWER-OFF</p> <p><b>Description:</b> Execute a display control off</p>
9	CEC_DISP_AUTO To define the display control automatically	<p><b>Command:</b> SEND_COMMAND &lt;DEV&gt;,"CEC_DISP_AUTO-&lt;ON OFF&gt;""</p> <p><b>Return:</b> 'CEC_DISP_AUTO-&lt;ON OFF&gt;</p>	<p><b>Command:</b> SEND_COMMAND &lt;DEV&gt;,"CEC_DISP_AUTO-OFF""</p> <p><b>Return:</b> CEC_DISP_AUTO-OFF</p> <p><b>Description:</b> Define the display control automatically off</p>

## NetLinx Commands (cont.)

No.	Function Description	Syntax	Example
10	?CEC_DISP_AUTO To verify the display control Status	<b>Command:</b> SEND_COMMAND <DEV>, ""?CEC_DISP_AUTO""  <b>Return:</b> CEC_DISP_AUTO-<ON OFF>	<b>Command:</b> SEND_COMMAND SWITCHER,""?CEC_DISP_AUTO""  <b>Return:</b> CEC_DISP_AUTO-ON  <b>Description:</b> Get the display control Status. The display control status is on.
11	CEC_SLEEP_TIMEOUT To define a Delay Time to control the display off when on active signal	<b>Command:</b> SEND_COMMAND <DEV>,""CEC_SLEEP_TIMEOUT-<time>""  <b>Return:</b> CEC_SLEEP_TIMEOUT-<time>  <b>Description:</b> time: {1 ~ 30}	<b>Command:</b> SEND_COMMAND <DEV>,""CEC_SLEEP_TIMEOUT-5""  <b>Return:</b> CEC_SLEEP_TIMEOUT-5  <b>Description:</b> Set Delay Time is 5 Minutes
12	?CEC_SLEEP_TIMEOUT To verify Delay Time to control the display off when on active signal	<b>Command:</b> SEND_COMMAND <DEV>, ""?CEC_SLEEP_TIMEOUT""  <b>Return:</b> CEC_SLEEP_TIMEOUT-<time>  <b>Description:</b> time: {1 ~ 30}	<b>Command:</b> SEND_COMMAND SWITCHER,""?CEC_SLEEP_TIMEOUT""  <b>Return:</b> CEC_SLEEP_TIMEOUT-5  <b>Description:</b> Get Delay Time to control the display off when on active signal. The Delay Time is 5 Minutes.
13	VIDIN_PREF_EDID To Set input EDID	<b>Command</b> SEND_COMMAND <DEV>,""VIDIN_PREF_EDID-<resolution>""  <b>Return:</b> VIDIN_PREF_EDID-<resolution>  <b>Description:</b> Input port: //{ VGA_IN; DP_IN; TX_HDMI_IN; USB-C_IN; RX_HDMI_IN1; RX_HDMI_IN2; }  <resolution> { For VGA Input 1920x1200,60 1920x1080,60 1680x1050,60 1600x900,60 1440x900,60 1360x768,60 1280x768,60 1024x768,60  For HDMI Input 3840x2160,60 3840x2160,30 1920x1080,60 1280x720,60 1920x1200,60 1680x1050,60 1600x1200,60 1600x900,60 1440x900,60 1400x1050,60 1366x768,60 1280x1024,60 1280x960,60 1024x768,60 COPY }	<b>Command:</b> SEND_COMMAND VIDEO_INPUT_2,""VIDIN_PREF_EDID-1920x1200,60""  <b>Return:</b> VIDIN_PREF_EDID-1920x1200,60  <b>Description:</b> Set fix EDID(1920x1200@60Hz 2CH)

## NetLinx Commands (cont.)

No.	Function Description	Syntax	Example
14	?VIDIN_PREF_EDID To Verify input EDID	<p><b>Command:</b> SEND_COMMAND &lt;DEV&gt;, ""?VIDIN_PREF_EDID""</p> <p><b>Return:</b> VIDIN_PREF_EDID-&lt;resolution&gt;</p> <p><b>Description:</b> Input port: //{ VGA_IN; DP_IN; TX_HDMI_IN; USB-C_IN; RX_HDMI_IN1; RX_HDMI_IN2; }  &lt;resolution&gt; { For VGA Input 1920x1200,60 1920x1080,60 1680x1050,60 1600x900,60 1440x900,60 1360x768,60 1280x768,60 1024x768,60  For HDMI Input 3840x2160,60 3840x2160,30 1920x1080,60 1280x720,60 1920x1200,60 1680x1050,60 1600x1200,60 1600x900,60 1440x900,60 1400x1050,60 1366x768,60 1280x1024,60 1280x960,60 1024x768,60 COPY }</p>	<p><b>Command:</b> SEND_COMMAND VIDEO_INPUT_1,""?VIDIN_PREF_EDID""</p> <p><b>Return:</b> VIDIN_PREF_EDID-1920x1200,60  : The EDID of the Input TX_HDMI_IN is fix EDID 1920x1200@60Hz 2CH</p>
15	VIDIN_HDCP To Set Input HDCP Compliant	<p><b>Command:</b> SEND_COMMAND &lt;DEV&gt;, ""VIDIN_HDCP-&lt;ENABLE   DISABLE&gt;""</p> <p><b>Return:</b> VIDIN_HDCP-&lt;ENABLE   DISABLE&gt;</p> <p><b>Description:</b> Input port: //{ TX_HDMI_IN; USB-C_IN; RX_HDMI_IN1; RX_HDMI_IN2; }</p>	<p><b>Command:</b> SEND_COMMAND VIDEO_INPUT_3,"VIDIN_HDCP-ENABLE""</p> <p><b>Return:</b> VIDIN_HDCP-ENABLE</p> <p><b>Description:</b> Set HDMI IN2 HDCP Compliant</p>
16	?VIDIN_HDCP To Get Input HDCP Compliant Status	<p><b>Command:</b> SEND_COMMAND &lt;DEV&gt;,""?VIDIN_HDCP""</p> <p><b>Return:</b> VIDIN_HDCP-&lt;ENABLE DISABLE&gt;</p> <p><b>Description:</b> Input port: //{ TX_HDMI_IN; USB-C_IN; RX_HDMI_IN1; RX_HDMI_IN2; }</p>	<p><b>Command:</b> SEND_COMMAND VIDEO_INPUT_3,""?VIDIN_HDCP""</p> <p><b>Return:</b> VIDIN_HDCP-ENABLE</p> <p><b>Description:</b> HDMI IN2 HDCP Compliant.</p>

## NetLinx Commands (cont.)

No.	Function Description	Syntax	Example
17	VIDOUT_RES_REF To set output resolution	<p><b>Command:</b> SEND_COMMAND &lt;DEV&gt;,""VIDOUT_RES_REF-&lt;horizontal&gt;x&lt;vertical&gt;,&lt;refresh-rate&gt;"</p> <p><b>Return:</b> NULL</p> <p><b>Description:</b> Variables: horizontal = An integer value representing the horizontal. vertical = An integer value representing the vertical. May have an additional qualifier such as 'i' or 'p'. refresh-rate = An integer value representing the refresh rate.</p> <pre>{   4096x2160,60   4096x2160,30   4096x2160,25   4096x2160,24   3840x2160,60   3840x2160,50   3840x2160,30   3840x2160,25   3840x2160,24   1920x1200,60   1920x1080,60   1920x1080,50   1280x720,60   1280x720,50   1680x1050,60   1600x1200,60   1600x900,60   1440x900,60   1366x768,60   1360x768,60   1280x1024,60   1280x960,60   1280x800,60   1280x768,60   1024x768,60   800x600,60 }</pre>	<p><b>Command:</b> SEND_COMMAND VIDEO_OUTPUT_1,""VIDOUT_RES_REF-1280x1024,60""</p> <p><b>Return:</b> VIDOUT_RES_REF-1280x1024,60</p> <p><b>Description:</b> Set HDMI out resolution is 1280x1024@60.</p>
18	?VIDOUT_RES_REF To get output resolution	<p><b>Command:</b> SEND_COMMAND &lt;DEV&gt;,""?VIDOUT_RES_REF"</p> <p><b>Return:</b> VIDOUT_RES_REF-&lt;horizontal&gt;x&lt;vertical&gt;,&lt;refresh-rate&gt;</p> <p><b>Description:</b> &lt;horizontal&gt;x&lt;vertical&gt;,&lt;refresh-rate&gt;</p> <pre>{   4096x2160,60   4096x2160,30   ... ..   1024x768,60   800x600,60 }</pre>	<p><b>Command:</b> SEND_COMMAND VIDEO_OUTPUT_1,""?VIDOUT_RES_REF"</p> <p><b>Return:</b> VIDOUT_RES_REF-3840x2160,60</p> <p><b>Description:</b> HDMI out resolution is 3840x2160@60.</p>
19	REBOOT To cause a warm reboot	<p><b>Command:</b> SEND_COMMAND &lt;DEV&gt;,""REBOOT"</p> <p><b>Return:</b> REBOOT</p> <p><b>Description:</b> Cause a warm reboot.</p>	<p><b>Command:</b> SEND_COMMAND 5002:1:0,""REBOOT"</p> <p><b>Return:</b> SEND_COMMAND 5002:1:0,""REBOOT"</p> <p><b>Description:</b> Cause a warm reboot.</p>

## NetLinx Commands (cont.)

No.	Function Description	Syntax	Example
20	?FWVERSION To determine the system's Application Code version	<b>Command:</b> SEND_COMMAND <DEV>,""?FWVERSION"  <b>Return:</b> FWVERSION <version-string>	<b>Command:</b> SEND_COMMAND dvRX,""?FWVERSION"  <b>Return:</b> FWVERSION-SCALER_V1.5 FWVERSION-STM32_V1.4
21	VIDOUT_SCALE Sets the scaling mode for the video output port	<b>Command:</b> SEND_COMMAND <DEV>,"VIDOUT_SCALE-<AUTO MANUAL>"  <b>Return:</b> VIDOUT_SCALE-<AUTO MANUAL>	<b>Command:</b> SEND_COMMAND VIDEO_OUTPUT_1,"VIDOUT_SCALE-AUTO"  <b>Return:</b> VIDOUT_SCALE-AUTO  <b>Description:</b> Set scale mode is auto
22	?VIDOUT_SCALE Gets the scaling mode for the video output port	<b>Command:</b> SEND_COMMAND <DEV>,""?VIDOUT_SCALE"  <b>Return:</b> VIDOUT_SCALE-<AUTO MANUAL>	<b>Command:</b> SEND_COMMAND VIDEO_OUTPUT_1,"?VIDOUT_SCALE"  <b>Return:</b> VIDOUT_SCALE-Auto  <b>Description:</b> Scale mode is auto
23	VIDOUT_MUTE Sets the video mute mode for the video output port	<b>Command:</b> SEND_COMMAND <DEV>,"VIDOUT_MUTE-<ENABLE DISABLE>"  <b>Return:</b> VIDOUT_MUTE<ENABLE DISABLE>	<b>Command:</b> SEND_COMMAND SWITCHER,"VIDOUT_MUTE-ENABLE"  <b>Return:</b> VIDOUT_MUTE-ENABLE  <b>Description:</b> Set Video mute mode is enable
24	?VIDOUT_MUTE Gets the video mute mode for the video output port	<b>Command:</b> SEND_COMMAND <DEV>,""?VIDOUT_MUTE"  <b>Return:</b> VIDOUT_MUTE<ENABLE DISABLE>	<b>Command:</b> SEND_COMMAND SWITCHER,"?VIDOUT_MUTE"  <b>Return:</b> VIDOUT_MUTE-DISABLE  <b>Description:</b> Video mute mode is disable
25	VIDOUT_RGB Sets the video color space for the video output port	<b>Command:</b> SEND_COMMAND <DEV>,"VIDOUT_RGB-<ENABLE DISABLE>"  <b>Return:</b> VIDOUT_RGB-<ENABLE DISABLE>	<b>Command:</b> SEND_COMMAND SWITCHER,"VIDOUT_RGB-ENABLE"  <b>Return:</b> VIDOUT_RGB-ENABLE  <b>Description:</b> Set Video out color space is RGB Device will reboot to take effect.
26	?VIDOUT_RGB Gets the video color space for the video output port	<b>Command:</b> SEND_COMMAND <DEV>,""?VIDOUT_RGB"  <b>Return:</b> VIDOUT_RGB-<ENABLE DISABLE>	<b>Command:</b> SEND_COMMAND SWITCHER,"?VIDOUT_RGB"  <b>Return:</b> VIDOUT_RGB-DISABLE  <b>Description:</b> Video out color space is YUV

## NetLinx Commands (cont.)

No.	Function Description	Syntax	Example
27	AUDOUT_MUTE Sets the audio mute mode for the audio output port	<b>Command:</b> SEND_COMMAND <DEV>,"AUDOUT_MUTE-<ENABLE DISABLE>" <b>Return:</b> AUDOUT_MUTE-<ENABLE DISABLE>	<b>Command:</b> SEND_COMMAND dxDev, ""?AUDOUT_MUTE" <b>Return:</b> AUDOUT_MUTE-disable <b>Description:</b> Audio mute mode is disable
28	?AUDOUT_MUTE Gets the audio mute mode for the audio output port	<b>Command:</b> SEND_COMMAND <DEV>, ""?AUDOUT_MUTE" <b>Return:</b> AUDOUT_MUTE-<ENABLE DISABLE>	<b>Command:</b> SEND_COMMAND dxDev, ""?AUDOUT_MUTE" <b>Return:</b> AUDOUT_MUTE-disable <b>Description:</b> Audio mute mode is disable
29	AUDOUT_MAXVOL Sets the audio max vol for the audio output port	<b>Command:</b> SEND_COMMAND <DEV>, ""AUDOUT_MAXVOL-<value>" <b>Return:</b> AUDOUT_MAXVOL-<value> <b>Description:</b> Variable: <value> = {0~100}	<b>Command:</b> SEND_COMMAND AUDIO_OUTPUT_1, ""AUDOUT_MAXVOL-75" <b>Return:</b> AUDOUT_MAXVOL-75 <b>Description:</b> Set Audio max is 75
30	?AUDOUT_MAXVOL Gets the audio max vol for the audio output port	<b>Command:</b> SEND_COMMAND <DEV>, ""?AUDOUT_MAXVOL" <b>Return:</b> AUDOUT_MAXVOL-<value> <b>Description:</b> <value> = {0~100}	<b>Command:</b> SEND_COMMAND AUDIO_OUTPUT_1, ""?AUDOUT_MAXVOL" <b>Return:</b> AUDOUT_MAXVOL-<100> <b>Description:</b> Audio max is 100
31	AUDOUT_MINVOL Sets the audio min vol for the audio output port	<b>Command:</b> SEND_COMMAND <DEV>, ""AUDOUT_MINVOL-<value>" <b>Return:</b> AUDOUT_MINVOL-<value> <b>Description:</b> <value> = {0~100}	<b>Command:</b> SEND_COMMAND AUDIO_OUTPUT_1, ""AUDOUT_MINVOL-5" <b>Return:</b> AUDOUT_MINVOL-5 <b>Description:</b> Set Audio min is 5
32	?AUDOUT_MINVOL Gets the audio min vol for the audio output port	<b>Command:</b> SEND_COMMAND <DEV>, ""?AUDOUT_MINVOL" <b>Return:</b> AUDOUT_MINVOL-<value> <b>Description:</b> <value> = {0~100}	<b>Command:</b> SEND_COMMAND AUDIO_OUTPUT_1, ""?AUDOUT_MINVOL" <b>Return:</b> AUDOUT_MINVOL-0 <b>Description:</b> Audio min is 0
33	AUDOUT_VOLUME Sets the audio vol for the audio output port	<b>Command:</b> SEND_COMMAND <DEV>, ""AUDOUT_VOLUME-<VALUE>" <b>Return:</b> AUDOUT_VOLUME-<VALUE> <b>Description:</b> <value> = {0~100}	<b>Command:</b> SEND_COMMAND AUDOUT_VOLUME_1, ""AUDOUT_VOLUME-50" <b>Return:</b> AUDOUT_VOLUME-50 <b>Description:</b> Set Audio vol is 50



## NetLinx Commands (cont.)

No.	Function Description	Syntax	Example
34	?AUDOUT_VOLUME Gets the audio vol for the audio output port	<p><b>Command:</b> SEND_COMMAND &lt;DEV&gt;,""?AUDOUT_VOLUME"</p> <p><b>Return:</b> AUDOUT_VOLUME-&lt;value&gt;</p> <p><b>Description:</b> &lt;value&gt; = {0~100}</p>	<p><b>Command:</b> SEND_COMMAND AUDOUT_VOLUME_1,""?AUDOUT_VOLUME"</p> <p><b>Return:</b> AUDOUT_VOLUME-50</p> <p><b>Description:</b> Audio volume is 50</p>
35	SET BAUD SET BAUD command for the Serial port	<p><b>Command:</b> SEND_COMMAND &lt;DEV&gt;,"SET BAUD &lt;baud&gt;,&lt;parity&gt;,&lt;data&gt;,&lt;stop&gt;"</p> <p><b>Return:</b> SET BAUD &lt;baud&gt;,&lt;parity&gt;,&lt;data&gt;,&lt;stop&gt;</p> <p><b>Description:</b> baud = baud rate with supported values of: 115200, 76800, 57600, 38400, 19200, 9600, 4800, 2400, 1200, 600, 300, 150. parity = N (none), O (odd), E (even), M (mark), S (space) data = 8 data bits stop = 1 or 2 stop bits</p>	<p><b>Command:</b> SEND_COMMAND dxDev,"SET_BAUD-9600,N,8,1"</p> <p><b>Return:</b> SET_BAUD- 9600,N,8,1</p>

## Telnet/SSH Commands

No.	Command	Description	Example
1	<b>help</b>	Displays all of the supported commands	<pre>&gt;help cpu usage      Displays the total CPU usage date           Display the current date. dns list      Show the DNS configuration of this device. get ip        Show the IP configuration of this device</pre>
2	<b>cpu usage</b>	Display the total CPU usage usage: cpu usage	<pre>&gt;cpu usage CPU usage is 25%</pre>
3	<b>date</b>	Display the current date. Usage: date	<pre>&gt;date The current date is: Thursday, January 1, 1970</pre>
4	<b>get ip</b>	Show the IP configuration of this device.	<pre>&gt;get ip --- Current IP Settings --- Hostname:      XXX IP Address:    192.168.2.201 Netmask:      255.255.240.0 DHCP:         false</pre>
5	<b>ping</b>	Ping an address. Address may be an IP or URL.	<pre>&gt;ping 192.16.2.203 PING 192.16.2.203 (192.16.2.203): 56 data bytes</pre>
6	<b>reset factory</b>	Reset configuration back to factory defaults.	<pre>&gt;reset factory</pre>
7	<b>set date</b>	Set the current date.	<pre>&gt;set date Usage: set date [day] [month] [year]  Arguments: day          integer of day of the week between 1 and 31 month       integer of month between 1 and 12 year        integer value of year later than 1900  Example: set date 01 11 2016</pre>
8	<b>set ip</b>	Setup the IP configuration of this device.	<pre>&gt;set ip --- Enter New Values or just hit Enter to keep current settings --- Enter IP Address      192.168.2.201    192.168.2.202 Enter Netmask        255.255.240.0    255.255.255.0  --- New settings --- IP Address            192.168.2.202 Netmask              255.255.255.0  Would you like to save the new settings? Y/N -&gt; y  New settings were saved.</pre>

## Telnet/SSH Commands (cont.)

No.	Command	Description	Example												
9	<b>set time</b>	Set the current time.	<p><b>&gt;set time</b></p> <p>Usage: set time [hours] [minutes] [seconds]</p> <p>Arguments:</p> <table> <tr> <td>hours</td> <td>integer value of hours between 0 and 23</td> </tr> <tr> <td>minutes</td> <td>integer value of minutes between 0 and 59</td> </tr> <tr> <td>seconds</td> <td>integer value of seconds between 0 and 59</td> </tr> </table> <p>Example: set time 13 30 00</p>	hours	integer value of hours between 0 and 23	minutes	integer value of minutes between 0 and 59	seconds	integer value of seconds between 0 and 59						
hours	integer value of hours between 0 and 23														
minutes	integer value of minutes between 0 and 59														
seconds	integer value of seconds between 0 and 59														
10	<b>show mem</b>	Display the memory usage for all memory types.	<p><b>&gt;show mem</b></p> <p>RAM available: 349634560 bytes RAM total: 406167552 bytes</p>												
11	<b>time</b>	Display the current time.	<p><b>&gt;time</b></p> <p>The current time is: 11: 57: 09 PM</p>												
12	<b>show vs100 stats</b>	Displays DXLink transport information (MSE values, length, etc.).	<p><b>&gt;show vs100 stats</b></p> <p>VS100 STATS: 50.</p>												
13	<b>echo</b>	Enable/disable echo of typed characters.	<p><b>&gt;echo</b></p> <p>Usage: echo [argument]</p> <p>Arguments:</p> <table> <tr> <td>on</td> <td>Enable echo of typed characters</td> </tr> <tr> <td>off</td> <td>Disable echo of typed characters</td> </tr> </table> <p>Example: echo on</p>	on	Enable echo of typed characters	off	Disable echo of typed characters								
on	Enable echo of typed characters														
off	Disable echo of typed characters														
14	<b>exit</b>	Close this terminal session.	<p><b>&gt;exit</b></p>												
15	<b>msg</b>	Enable/Disable extended diagnostic messages.	<p><b>&gt;msg</b></p> <p>Usage: msg [argument]</p> <p>This command allows system logs to be redirected to the terminal session. There are multiple log levels, which are described below.</p> <p>Arguments:</p> <table> <tr> <td>on</td> <td>Enable default [warning] system log level</td> </tr> <tr> <td>debug</td> <td>Enable all system debug messages</td> </tr> <tr> <td>info</td> <td>Enable info system log level</td> </tr> <tr> <td>warning</td> <td>Enable warning system log level</td> </tr> <tr> <td>error</td> <td>Enable error system log level</td> </tr> <tr> <td>off</td> <td>Disable system log output to terminal session</td> </tr> </table> <p>Example: msg on</p>	on	Enable default [warning] system log level	debug	Enable all system debug messages	info	Enable info system log level	warning	Enable warning system log level	error	Enable error system log level	off	Disable system log output to terminal session
on	Enable default [warning] system log level														
debug	Enable all system debug messages														
info	Enable info system log level														
warning	Enable warning system log level														
error	Enable error system log level														
off	Disable system log output to terminal session														
16	<b>reboot</b>	Reboot the device.	<p><b>&gt;reboot</b></p>												

## Telnet/SSH Commands (cont.)

No.	Command	Description	Example
17	<b>set dns</b>	Set DNS service	<pre>&gt;set dns --- Enter new values or keep current settings at the prompts ---  -- Current DNS #1 Change the current value?      Y/N -&gt; y Enter DNS #1                    192.168.2.1  -- Current DNS #2 Change the current value?      Y/N -&gt; Y Enter DNS #2                    192.168.3.1  Would you like to save the new settings?  Y/N -&gt; Y  New settings were saved...</pre>
18	<b>dns list</b>	Display the current dns.	<pre>&gt;dns list Domain Name: amx.com DNS List: DNS #1:      192.168.2.1 DNS #2:      192.168.3.1</pre>
19	<b>set friendlyname</b>	Set friendlyname	<pre>&gt;set friendlyname  Please input friendlyname:  Old friendlyname: New friendlyname: 111 Would you like to save this setting(Y/N)  y Setting is ok , you should reboot that make it effective</pre>
20	<b>set location</b>	It's setting location.	<pre>&gt;set location  Please input location:  Old location: New location: 333 Would you like to save this setting(Y/N)  y Setting is ok , you should reboot that make it effective</pre>
21	<b>set connection</b>	Set the master connection settings.	<pre>&gt;set connection  --- Enter New Values or just hit Enter to keep current settings ---  Enter Mode Type T for TCP/URL, U for UDP/URL, N for NDP or A for Auto and then Enter:  Icsp_Auto   A Enter Master System Number:   1           1  --- New settings --- System Number  1 Master Port   1319 Is this correct? Type Y or N and Enter -&gt; Y Changed &amp;&amp; Saved</pre>
22	<b>get connection</b>	Get the master connection settings.	<pre>&gt;get connection  Connection Mode:   Icsp_Auto System Number:    1 Master Ip/URL Master Port:      1319</pre>
23	<b>set telnet username</b>	Set telnet service login username	<pre>&gt;set telnet username  Enter Telnet new username           123 Would you like to set this username (y/n)  y (please set telnet password)  Changed &amp;&amp; Saved</pre>

## Telnet/SSH Commands (cont.)

No.	Command	Description	Example
24	<b>set telnet password</b>	Set telnet service login password	<b>&gt;set telnet password</b> Enter Telnet new password 456 Would you like to set this password (y/n) y Changed && Saved
25	<b>set ssh username</b>	Set ssh service login username	<b>&gt;set ssh username</b> Enter ssh new username admin admin Would you like to set this username (y/n) y Changed && Saved (you should reboot this device that make your setting active)
26	<b>set ssh password</b>	Set ssh service login password	<b>&gt;set ssh password</b> Enter ssh new password password pass Would you like to set this password (y/n) y Changed && Saved (you should reboot this device that make your setting active)



LAST REVISED: 01/22/2019

#### About AMX by HARMAN

Founded in 1982 and acquired by HARMAN in 2014, AMX® is dedicated to providing AV solutions for an IT World. AMX solves the complexity of managing technology with reliable, consistent and scalable systems comprising control, video switching and distribution, digital signage and technology management. AMX systems are deployed worldwide in conference rooms, classrooms, network operation/command centers, homes, hotels, entertainment venues and broadcast facilities, among others. AMX is part of the HARMAN Professional Group, the only total audio, video, lighting, and control vendor in the professional AV market. HARMAN designs, manufactures and markets premier audio, video, infotainment and integrated control solutions for the automotive, consumer and professional markets. ©2019 Harman. All rights reserved. Specifications subject to change.

[www.amx.com](http://www.amx.com) | +1.469.624.7400 | 800.222.0193