



USER MANUAL

# N1512 4X1 WINDOWING PROCESSOR HIGH-RESOLUTION, WINDOW PROCESSING OVER AN ETHERNET LAN

NMX-WP-N1512



## IMPORTANT SAFETY INSTRUCTIONS

1. READ these instructions.
2. KEEP these instructions.
3. HEED all warnings.
4. FOLLOW all instructions.
5. DO NOT use this apparatus near water.
6. CLEAN ONLY with dry cloth.
7. DO NOT block any ventilation openings. Install in accordance with the manufacturer's instructions.
8. DO NOT install near any heat sources such as radiators, heat registers, stoves, or other apparatus (including amplifiers) that produce heat.
9. DO NOT defeat the safety purpose of the polarized or grounding type plug. A polarized plug has two blades with one wider than the other. A grounding type plug has two blades and a third grounding prong. The wider blade or the third prong are provided for your safety. If the provided plug does not fit into your outlet, consult an electrician for replacement of the obsolete outlet.
10. PROTECT the power cord from being walked on or pinched, particularly at plugs, convenience receptacles, and the point where they exit from the apparatus.
11. ONLY USE attachments/accessories specified by the manufacturer.
12. UNPLUG this apparatus during lightning storms or when unused for long periods of time.
13. REFER all servicing to qualified service personnel. Servicing is required when the apparatus has been damaged in any way, such as power-supply cord or plug is damaged, liquid has been spilled or objects have fallen into the apparatus, the apparatus has been exposed to rain or moisture, does not operate normally, or has been dropped.
14. DO NOT expose this apparatus to dripping or splashing and ensure that no objects filled with liquids, such as vases, are placed on the apparatus.
15. To completely disconnect this apparatus from the AC Mains, disconnect the power supply cord plug from the AC receptacle.
16. Where the mains plug or an appliance coupler is used as the disconnect device, the disconnect device shall remain readily operable.
17. DO NOT overload wall outlets or extension cords beyond their rated capacity as this can cause electric shock or fire.



The exclamation point, within an equilateral triangle, is intended to alert the user to the presence of important operating and maintenance (servicing) instructions in the literature accompanying the product.



The lightning flash with arrowhead symbol within an equilateral triangle is intended to alert the user to the presence of uninsulated "dangerous voltage" within the product's enclosure that may be of sufficient magnitude to constitute a risk of electrical shock to persons.



ESD Warning: The icon to the left indicates text regarding potential danger associated with the discharge of static electricity from an outside source (such as human hands) into an integrated circuit, often resulting in damage to the circuit.

- WARNING:** To reduce the risk of fire or electrical shock, do not expose this apparatus to rain or moisture.
- WARNING:** No naked flame sources - such as candles - should be placed on the product.
- WARNING:** Equipment shall be connected to a MAINS socket outlet with a protective earthing connection.
- WARNING:** To reduce the risk of electric shock, grounding of the center pin of this plug must be maintained.

## COPYRIGHT NOTICE

AMX© 2016, all rights reserved. No part of this publication may be reproduced, stored in a retrieval system, or transmitted, in any form or by any means, electronic, mechanical, photocopying, recording, or otherwise, without the prior written permission of AMX. Copyright protection claimed extends to AMX hardware and software and includes all forms and matters copyrightable material and information now allowed by statutory or judicial law or herein after granted, including without limitation, material generated from the software programs which are displayed on the screen such as icons, screen display looks, etc. Reproduction or disassembly of embodied computer programs or algorithms is expressly prohibited.

## LIABILITY NOTICE

No patent liability is assumed with respect to the use of information contained herein. While every precaution has been taken in the preparation of this publication, AMX assumes no responsibility for error or omissions. No liability is assumed for damages resulting from the use of the information contained herein. Further, this publication and features described herein are subject to change without notice.

## AMX WARRANTY AND RETURN POLICY

The AMX Warranty and Return Policy and related documents can be viewed/downloaded at [www.amx.com](http://www.amx.com).

## ESD WARNING

	<p>To avoid ESD (Electrostatic Discharge) damage to sensitive components, make sure you are properly grounded before touching any internal materials.</p> <p>When working with any equipment manufactured with electronic devices, proper ESD grounding procedures must be followed to make sure people, products, and tools are as free of static charges as possible. Grounding straps, conductive smocks, and conductive work mats are specifically designed for this purpose.</p> <p>Anyone performing field maintenance on AMX equipment should use an appropriate ESD field service kit complete with at least a dissipative work mat with a ground cord and a UL listed adjustable wrist strap with another ground cord</p>
---	--

	<p><b>WARNING:</b> Do Not Open! Risk of Electrical Shock. Voltages in this equipment are hazardous to life. No user-serviceable parts inside. Refer all servicing to qualified service personnel.</p> <p>Place the equipment near a main power supply outlet and make sure that you can easily access the power breaker switch.</p>
---	---

**WARNING:** This product is intended to be operated ONLY from the voltages listed on the back panel or the recommended, or included, power supply of the product. Operation from other voltages other than those indicated may cause irreversible damage to the product and void the products warranty. The use of AC Plug Adapters is cautioned because it can allow the product to be plugged into voltages in which the product was not designed to operate. If the product is equipped with a detachable power cord, use only the type provided with your product or by your local distributor and/or retailer. If you are unsure of the correct operational voltage, please contact your local distributor and/or retailer.

## FCC AND CANADA EMC COMPLIANCE INFORMATION:

This device complies with part 15 of the FCC Rules. Operation is subject to the following two conditions:

- (1) This device may not cause harmful interference, and (2) this device must accept any interference received, including interference that may cause undesired operation.

NOTE: This equipment has been tested and found to comply with the limits for a Class A digital device, pursuant to part 15 of the FCC Rules. These limits are designed to provide reasonable protection against harmful interference in a residential installation. This equipment generates, uses and can radiate radio frequency energy and, if not installed and used in accordance with the instructions, may cause harmful interference to radio communications. However, there is no guarantee that interference will not occur in a particular installation. If this equipment does cause harmful interference to radio or television reception, which can be determined by turning the equipment off and on, the user is encouraged to try to correct the interference by one or more of the following measures:

- Reorient or relocate the receiving antenna.
- Increase the separation between the equipment and receiver.
- Connect the equipment into an outlet on a circuit different from that to which the receiver is connected.
- Consult the dealer or an experienced radio/TV technician for help.

Approved under the verification provision of FCC Part 15 as a Class A Digital Device.

Caution: Changes or modifications not expressly approved by the manufacturer could void the user's authority to operate this device.

CAN ICES-3 (B)/NMB-3(B)

## EU COMPLIANCE INFORMATION:

Eligible to bear the CE mark; Conforms to European Union Low Voltage Directive 2006/95/EC; European Union EMC Directive 2004/108/EC; European Union Restriction of Hazardous Substances Recast (RoHS2) Directive 2011/65/EU.

## WEEE NOTICE:

	<p>This appliance is labeled in accordance with European Directive 2012/19/EU concerning waste of electrical and electronic equipment (WEEE). This label indicates that this product should not be disposed of with household waste. It should be deposited at an appropriate facility to enable recovery and recycling.</p>
---	--

---

# TABLE OF CONTENTS

<b>Chapter 1: Introducing Your New N1512 Windowing Processor</b>	<b>6</b>
Product Overview	6
Basic Specifications	6
Windowing Processor Hardware Overview	6
Application Example	8
<b>Chapter 2: Installing and Configuring the Windowing Processor</b>	<b>9</b>
Rack-Mounting Options	9
Preparing for Install	9
Setting Up Your Host Computer	10
Logging in Using N-Able Software	12
Logging in to the Windowing Processor’s Web Interface	13
Configuring IP addresses (if needed)	14
How IP Address Changes Affect Unit Control	14
Changing IP Addresses	14
Option 1: Assigning IP Addresses Individually (using the Settings page)	14
Option 2: Assigning IP Addresses to Multiple Units (using CSV files)	15
Control Options	15
Primary Control Options	15
N-Command Controllers	15
Third-Party Controllers	15
N-Touch   IP Wall Controller	15
<b>Chapter 3: Windowing Processor Configuration Options</b>	<b>16</b>
Arrangement Page	17
Crop/Pan/Zoom Page	19
Unit Settings Page	20
Unit Setup Section	21
Stored Presets Section	22
Network Setup Section	23
Network Setup for U0-U3 Section	24
Change Password Section	24
Software Section	24
Security Page	25
LLDP Page	25
Logs Page	26
NetLinx Page	27
<b>Chapter 4: Troubleshooting</b>	<b>28</b>
<b>Appendix A: NetLinx Control</b>	<b>29</b>
Introduction	29
Common Applications	29
NetLinx Configuration Using the Unit’s Webpage	29
Batch Configurations Using N-Able	30

---

Native Commands Port 1 .....	31
Windowing Processor Pass Through Command Examples .....	32
<b>Appendix B: Minimum Network Requirements .....</b>	<b>33</b>

# Chapter 1: Introducing Your New N1512 Windowing Processor

## Product Overview

The NMX-WP-N1512 4x1 Windowing Processor allows you to display multiple real-time HD streams on a single screen simultaneously. Four window streams (from N1000 Series Encoders) are connected to the four independent network ports labeled U0-U3. Each window stream can then be cropped, scaled, and positioned according to stored presets (such as quad, picture-in-picture, etc.) or in any user-defined configuration. The combined output AV stream is then routed as a single N1000 stream to one or more displays via a single output network port (any of the ports P0-P2).

**NOTE:** For proper operation, all four U ports must be connected to active streams.

**IMPORTANT:** To avoid creating a network loop, never connect more than one P port to the same network segment.

To achieve larger stacked configurations, additional Windowing Processors can be used as input streams.

## Basic Specifications

- Power Requirements: 120 or 230VAC (auto-sensing) power supply
- Dimensions (HWD): 1.75"(H) x 17.25"(W) x 12"(D) - (4.5 x 43.8 x 30.5 cm)
- Weight: 7.15 lbs (3.24 kg)
- Certifications: FCC, CE, and UL
- Temperature: 32° to 104°F (0° to 40°C)
- Humidity: 10% to 90% RH (non-condensing)
- Rack-mountable, 1U unit (mounting ears included in shipment)

## Windowing Processor Hardware Overview

Refer to the following figures (front and rear panel drawings of the N1512) as well as the [Front and Rear Panel Descriptions table](#) on page 7 for hardware details.

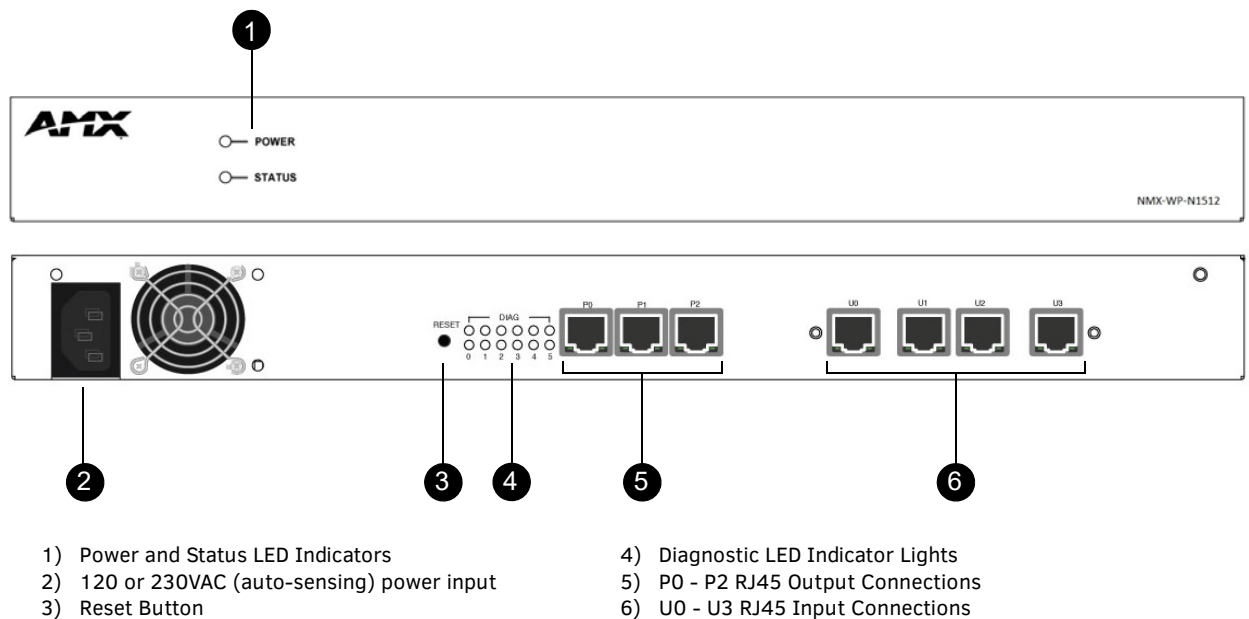
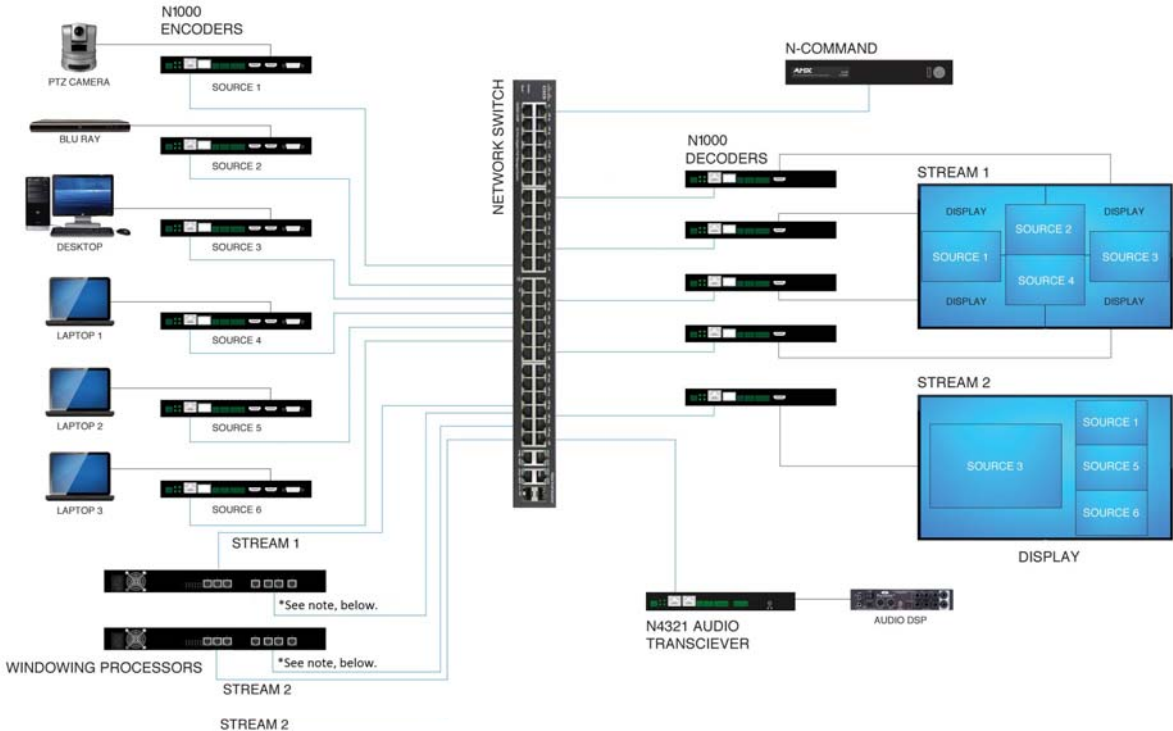

**FIG. 1** Front and Rear Panels

**TABLE 1** Front and Rear Panel Descriptions

<b>Front Panel</b>	
POWER LED	On solid (green) when operating power is supplied (via local power supply).
STATUS LED	On green signifies CPU activity/status.
<b>Rear Panel</b>	
Power Input	120 or 230VAC (auto-sensing)
Reset Button	Recessed pushbutton. Press to initiate a “warm restart” which causes the processor to reset, but not lose power. A reset does NOT affect the current settings. Press and hold for 30 seconds to perform a factory restore.
Diagnostic LEDs	<p><b>LEDs 0-3</b> Lower row: On solid green signifies receipt of active input stream. Upper row: Blinking green signifies input processor activity.</p> <p><b>LED 4</b> Upper and Lower: N-Series diagnostics.</p> <p><b>LED 5</b> Upper row: Blinking green signifies CPU activity/status. Lower row: Blinking green signifies output processor activity/status.</p>
P0-P2 Ports	8-wire RJ45 female. 10/100/1000 Mbps 10/100/1000Base-T auto-sensing gigabit Ethernet switch port.
U0-U3 Ports	8-wire RJ45 female. 1000Base-T gigabit Ethernet port.

# Application Example



*\*Note: Single line represents four independent connections from ports U0-U3 to the switch.*

**FIG. 2** Windowing Processor Application Example



# Chapter 2: Installing and Configuring the Windowing Processor

## Rack-Mounting Options

N1512 units can be free standing or rack mounted. Rack-mount ears are included in shipment. For all rack-mounted equipment, please adhere to the following safety guidelines:

- **Elevated Operating Ambient** - If installed in a closed or multi-unit rack assembly, the operating ambient temperature of the rack environment may be greater than room ambient. Therefore, consideration should be given to installing the equipment in an environment compatible with the maximum ambient temperature (TMA) specified by the manufacturer.
- **Reduced Air Flow** - Installation of the equipment in a rack should be such that the amount of air flow required for safe operation of the equipment is not compromised.
- **Mechanical Loading** - Mounting of the equipment in the rack should be such that a hazardous condition is not achieved due to uneven mechanical loading.
- **Circuit Overloading** - Consideration should be given to the connection of the equipment to the supply circuit and the effect that overloading of the circuits might have on overcurrent protection and supply wiring. Appropriate consideration of equipment nameplate ratings should be used when addressing this concern.
- **Reliable Earthing** - Reliable earthing of rack-mounted equipment should be maintained. Particular attention should be given to supply connections other than direct connections to the branch circuit (e.g., use of power strips).

## Preparing for Install

This section provides step-by-step guidance for installing and configuring equipment from the N-Series product family on your network. The steps provided here assume the following to be true:

1. *There are switches operational on the network.*  
N-Series equipment can operate on many different brands of networking equipment. The network itself needs to meet certain requirements to be able to support deployment. These instructions assume that you have purchased and installed a pre-configured switch from AMX or that your existing equipment meets the following physical and protocol requirements:
  - Layer 2 (with IGMP Multicast Protocol), OR Layer 3 (also known as “multi-layer”)
  - Gigabit Ethernet
  - IGMP Snooping
  - IGMP Snooping Querier (which only needs to be enabled on a single switch within the network)

**NOTE:** *To proceed with this installation, the switches must already be successfully connected to your network. If needed, refer to your product's documentation for installation instructions.*
2. *Deployment considerations have been made for the addition of high-speed video.*  
Our Networked AV solutions provide unsurpassed video and audio quality at bandwidths appropriate to any network segment or link. Matrix switches as large as 1200x800 have been constructed on a house network using N-Series equipment. Alternatively, many customers choose to deploy on physically separate networks in order to use low-cost network appliances but keep video traffic separate from data and voice.
3. *N-Able software has been loaded on the computer you are using to configure the equipment.*  
From your host computer, download N-Able (our free setup utility software):  
PC version - <http://www.amx.com/products/N-ABLE-PC.asp>  
Mac version - <http://www.amx.com/products/N-ABLE-MAC.asp>  
This software is designed to set up and control the equipment during initial deployment, however, it is not always the best solution for production-type or primary user control. Refer to [Control Options on page 15](#) for details.

**NOTE:** *For a more detailed requirements list, refer to [Appendix B: Minimum Network Requirements on page 33](#).*

## Setting Up Your Host Computer

In order to communicate with N-Series products, your devices must be on the same subnet as the host computer. N1512 devices are shipped in **DHCP** mode. The IP address will be assigned automatically based on the network DHCP server. If no DHCP server is found, the unit will switch to **Auto IP** mode with a default IP address of 169.254.xxx.xxx.

Before beginning installation, you will need to make some changes to the computer running N-Able. These steps show how this can be accomplished in a Microsoft Windows environment.

1. From the **Start** menu, select **Control Panel > Network and Sharing Center**.

2. Select **Change adapter settings**.

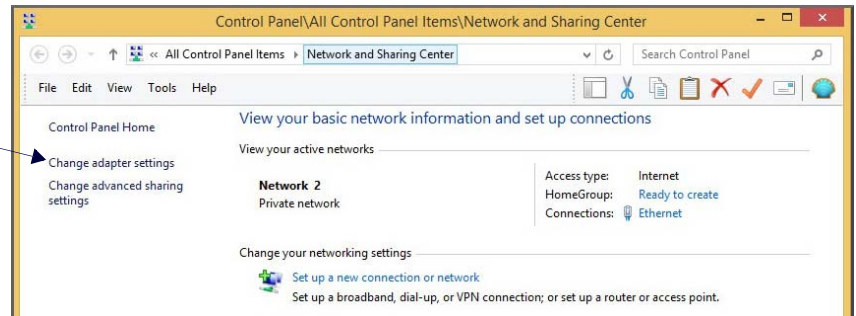

3. Double-click the wired interface to your AV network, and then click the **Properties** button.

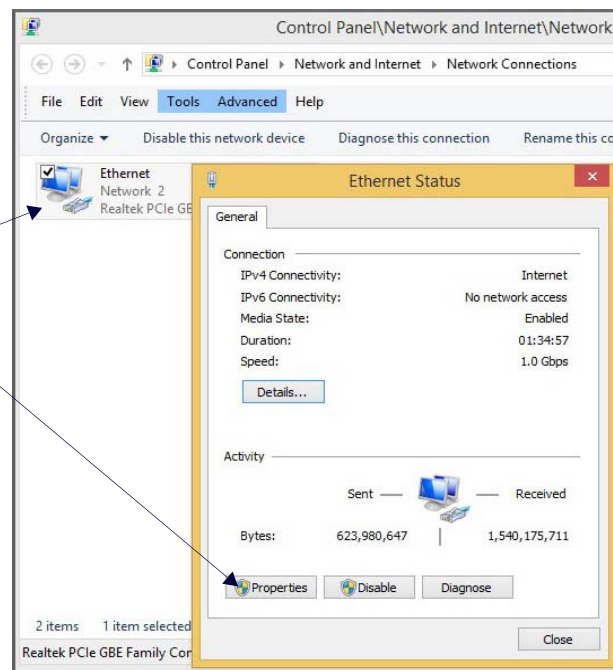

4. Scroll down in the list to the **Internet Protocol Version 4 (TCP/IPv4)** option. Highlight it and click the **Properties** button.

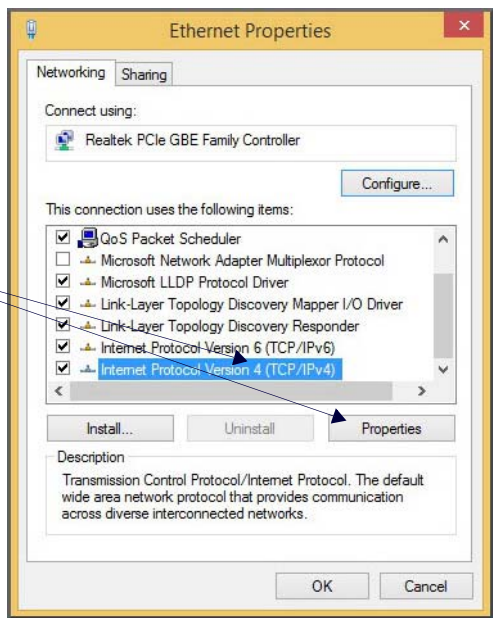

5. Enable the **Use the following IP address** option, and enter the static IP address provided to you by your network administrator.

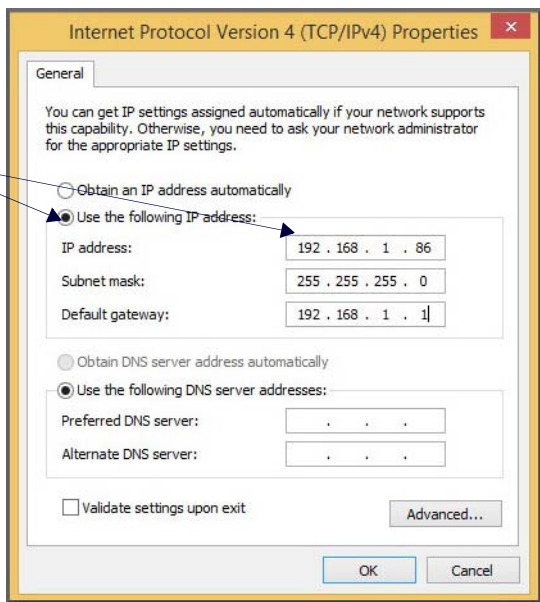

**NOTE:** If the computer does not need Internet access, you can simply enter a unique 169.254.xxx.xxx IP address with a 255.255.0.0 subnet mask. Contact your network administrator if you are unsure of how to configure the existing network. N-Series units in Auto IP mode will not self-assign in the 169.254.0.xxx range.

**NOTE:** If the computer has a statically-assigned IP address, click the Advanced button. Then click Add to enter a unique 169.254.xxx.xxx address with a Subnet Mask of 255.255.0.0 and a Default Gateway of 169.254.1.1 (if required).

## Logging in Using N-Able Software

Once the host IP address is configured properly on the host computer, launch N-Able to view all discovered units. The N1512 units appear on the following tabs:

- **Unit Management** tab - **Windowing Processor** is listed in the **Type** field.
- **Video Matrix** tab - N1512 units are found on the **N1000** sub-tab of the **Video Matrix**.

**NOTE:** If the tables in N-Able do not automatically populate, select the **Unit Management** tab and click the **Auto Discover** button. See [Figure 3](#).

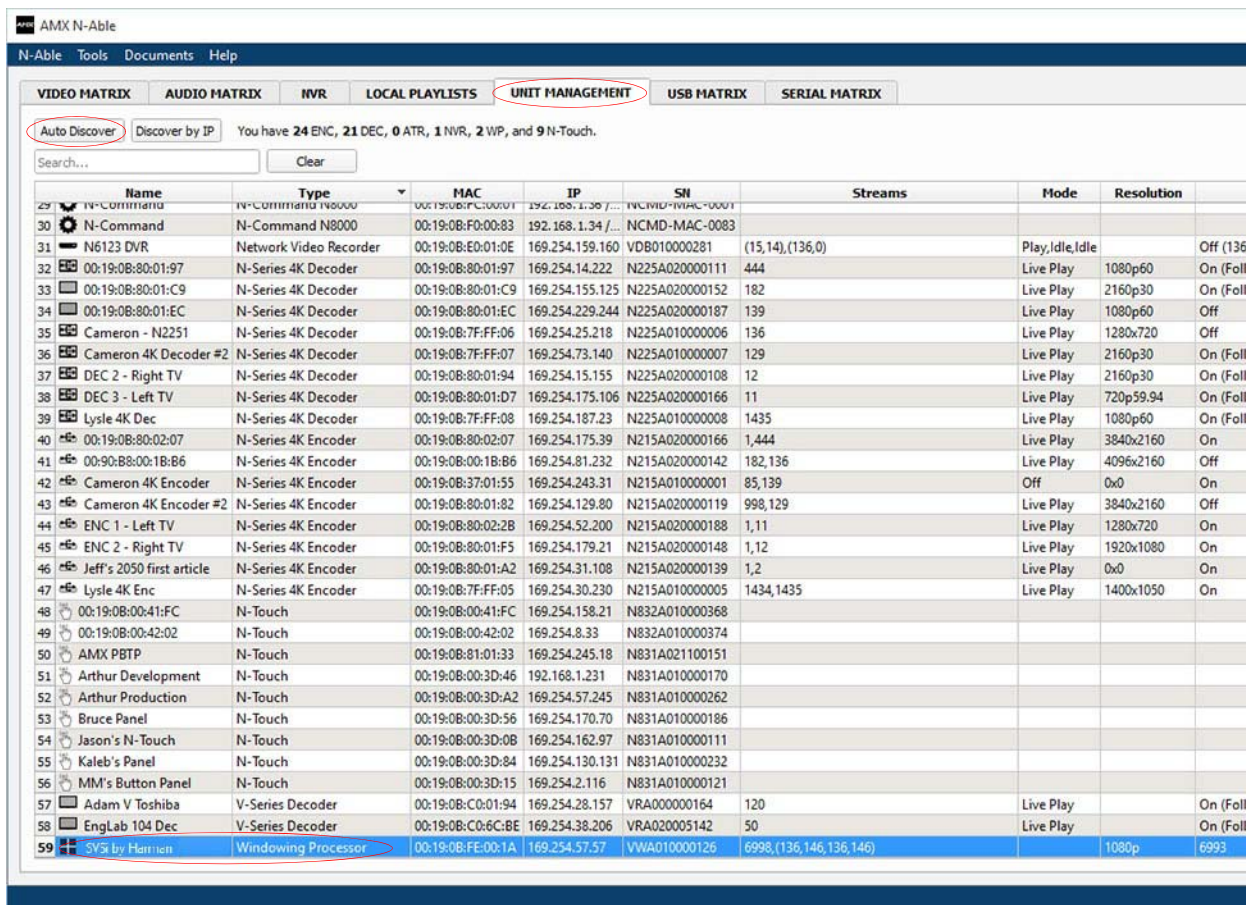

FIG. 3 UNIT MANAGEMENT PAGE

### Logging in to the Windowing Processor's Web Interface

Now that you have discovered your units in N-Able, follow these directions to access an individual unit's web interface. This interface provides a complete set of configuration options for the unit.

1. Double-click the N1512's name (on either the **Video Matrix** or **Unit Management** tab) to view its configuration pages.

ID	Name	Type	IP	MAC	Serial	Resolution	Frame Rate	Audio	Video	Control		
46	Jeff's 2050 first article	N-Series 4K Encoder	00:19:0B:80:01:A2	169.254.31.108	N215A020000139	1,2				Live Play	0x0	On
47	Lysle 4K Enc	N-Series 4K Encoder	00:19:0B:7F:FF:05	169.254.30.230	N215A010000005	1434,1435				Live Play	1400x1050	On
48	00:19:0B:00:41:FC	N-Touch	00:19:0B:00:41:FC	169.254.158.21	N832A010000368							
49	00:19:0B:00:42:02	N-Touch	00:19:0B:00:42:02	169.254.8.33	N832A010000374							
50	AMX PBTP	N-Touch	00:19:0B:81:01:33	169.254.245.18	N831A021100151							
51	Arthur Development	N-Touch	00:19:0B:00:3D:46	192.168.1.231	N831A010000170							
52	Arthur Production	N-Touch	00:19:0B:00:3D:A2	169.254.57.245	N831A010000262							
53	Bruce Panel	N-Touch	00:19:0B:00:3D:56	169.254.170.70	N831A010000186							
54	Jason's N-Touch	N-Touch	00:19:0B:00:3D:0B	169.254.162.97	N831A010000111							
55	Kaleb's Panel	N-Touch	00:19:0B:00:3D:84	169.254.130.131	N831A010000232							
56	MM's Button Panel	N-Touch	00:19:0B:00:3D:15	169.254.2.116	N831A010000121							
57	Adam V Toshiba	V-Series Decoder	00:19:0B:C0:01:94	169.254.28.157	VRA000000164	120				Live Play		On
58	EngLab 104 Dec	V-Series Decoder	00:19:0B:C0:6C:BE	169.254.38.206	VRA020005142	50				Live Play		On
59	SVSi by Harman	Windowing Processor	00:19:0B:FE:00:1A	169.254.57.57	VWA010000126	6998, (136,146,136,146)					1080p	69

FIG. 4 SELECTING WINDOWING PROCESSOR IN N-ABLE

**NOTE:** If prompted, enter admin and password for the default username and password. Once logged in, you can change the password (using the options on the Unit Settings page). The Login page is only displayed if N-Able's stored username/password does not match the unit's username/password. A default system will match.

**NOTE:** If you would like for N-Able to support auto-login to your units, make sure N-Able's Device Auto-login settings match the unit's username and password (by selecting N-Able > Settings from the N-Able tool bar).

2. The Arrangement page is displayed (see Figure 5).

From any main page in the web interface, you can access all other main pages by clicking the links in the top navigation bar.

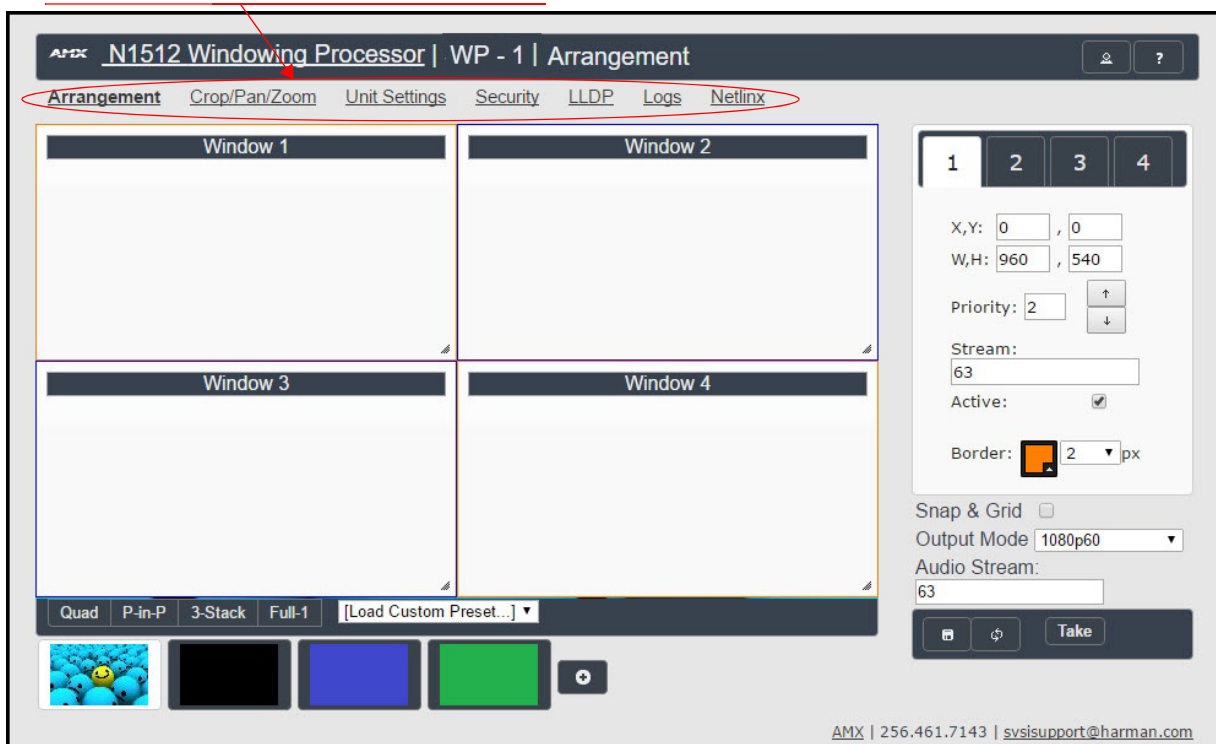

FIG. 5 ARRANGEMENT PAGE

**NOTE:** Screen-by-screen descriptions of the web interface options are provided for your reference in [Chapter 3: Windowing Processor Configuration Options on page 16](#).



## Configuring IP addresses (if needed)

IP configuration changes must be done correctly to avoid any communication disruptions with the N1512 unit.

As mentioned previously, the default IP mode for N1512 devices is **DHCP** mode. When first connected to the network, an IP address is assigned automatically based on the network DHCP server. If no DHCP server is found, the unit will use **Auto IP** mode.

### How IP Address Changes Affect Unit Control

N-able control is dependent upon the host computer being in the same IP address range as the N-Series devices. Therefore, before making any N1512 IP address changes, we recommend having **two statically-assigned IP addresses on your computer**.

- Configure the first IP address to be in the range of the default N-Series IP settings (i.e., in the 169.254.xxx.xxx range), AND
- Configure a second IP address in the range of the IP address you are planning to assign to the units (or when using DHCP, an address within the defined range for your network).

### Changing IP Addresses

There are two ways to assign new IP addresses to your N1512 units using N-able:

- **Option 1:** Log in to each unit individually and make the changes on the **Unit Settings** page.
- **Option 2:** Export a comma-separated value (CSV) file, make changes to all units in the resulting file, and import the CSV file into N-able to apply the changes.

#### Option 1: Assigning IP Addresses Individually (using the Settings page)

1. Find the unit you wish to change in the control matrix (either on the **Unit Management** tab or the **Video Matrix** tab).
2. Double-click the unit and log in.
3. Go to the **Unit Settings** page and make IP address changes for that unit either by setting a **STATIC** address or by enabling **DHCP** (see [Figure 6](#)).

**FIG. 6** NETWORK SETUP SECTIONS OF THE UNIT SETTINGS PAGE

4. Click the **Trial Save IP** button.
5. Return to the **Unit Settings** page through the newly-configured IP address.
6. Once the **Unit Settings** page appears (successfully using the new IP address) you can confirm the new address and lock in your changes.

**NOTE:** If you lose communication before you are able to confirm the new address, unplug the N1512, wait one minute, and plug it back in. This restores the unit to the original IP address.

## Option 2: Assigning IP Addresses to Multiple Units (using CSV files)

N-Able has the ability to export and import CSV files. Once units are auto-discovered in N-Able, the CSV file can be exported into Excel where parameters such as IP address, subnet mask, gateway, stream number, audio settings, etc. can be configured. Once configured, import the CSV file back into N-Able to assign those parameters to the appropriate devices. Reboot the devices to activate the new settings. This procedure can be used to configure multiple networked AV devices at the same time. It can also provide valuable diagnostics by allowing you to see the last known device configuration as well as scan the network for new devices (regardless of IP configuration).

To configure units using a CSV file, follow these steps:

1. Make sure that you have performed an **Auto Discover** (on the **Unit Management** tab of N-Able) since connecting all of the new units to the network.
2. From N-Able's main menu bar, select **N-Able > Export CSV**. See [Figure 7](#).

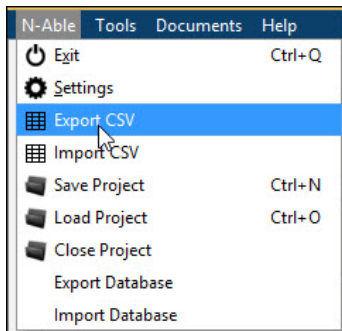

FIG. 7 EXPORT CSV FILE

3. From the **CSV Output Columns** window, select the fields you would like to be included in the CSV file. Hold the **<Ctrl>** key to select multiple fields.
4. Click **Yes** on the pop-up box informing you that a CSV file is about to be generated.

**NOTE:** A CSV file editor (e.g., Microsoft Excel) is necessary to proceed.

5. The folder containing your CSV file displays. Double-click the file to open it.
6. You can use this file to edit the IP mode, IP address, subnet mask, gateway IP address, stream number, etc. Once all changes have been made, save the file.
7. Go back into N-Able and select **N-Able > Import CSV**.
8. Browse to your saved CSV file and click **Import**.

## Control Options

N-Series control solutions (N-Command, N-Act, and N-Touch) provide you with the most flexible management options available, insuring you are getting the most from your digital media system.

### Primary Control Options

During initial configuration and setup, the free N-Able setup utility is sufficient. However, we do not recommend N-Able for production-level, primary-user control.

### N-Command Controllers

These web-based hardware Controllers offer intuitive, powerful management of equipment, content, Windowing Processors, NVR recording/playback, bandwidth utilization, and AV switching (using a web-based, point-and-click graphical matrix). The N-Command product line also offers:

- Simplified ASCII interface for third-party control via TCP/IP.
- N8002 and N8012 controllers have master/slave failover protection.
- N8012 controller has hot-swappable drives and redundant power supplies.
- Graphical presentation of video network connections.
- Full configuration control: assign fixed IP addresses for each N-Series component, adjust variable bit-rate for each video stream, etc.
- Additional software bundles (free with N-Command) allow you to easily create attractive touch panels for N-Series and third-party equipment control, as well as build software design walls of any size. Visit our website for more details on the available N-Command Controllers.

### Third-Party Controllers

The N1512 is capable of interfacing with third-party control systems such as Crestron. For direct control of N1512 units from any Third Party Control system, please use the Direct Control API (available on our website).

### N-Touch | IP Wall Controller

This 240 x 320 capacitive touch display has Wi-Fi and Bluetooth for expanding control to mobile devices. Programming is done individually through the built-in web server or collectively to multiple units using an N-Command N8000 Series Controller. Multi-page custom graphics can be created using the free Panel Builder software (stored internally).

# Chapter 3: Windowing Processor Configuration Options

This chapter defines N1512 Windowing Processor web interface configuration options. For ease of navigation, it is organized to reflect the structure of the graphical user interface (GUI).

**NOTE:** For instructions on accessing the Windowing Processor web interface, refer back to the [Logging in to the Windowing Processor's Web Interface section on page 13](#).

From any main page in the GUI, you can access all other main pages by clicking the links in the top navigation bar. [Figure 8](#) shows the navigation bar and provides hot links to the sections of this chapter which describe each main page.

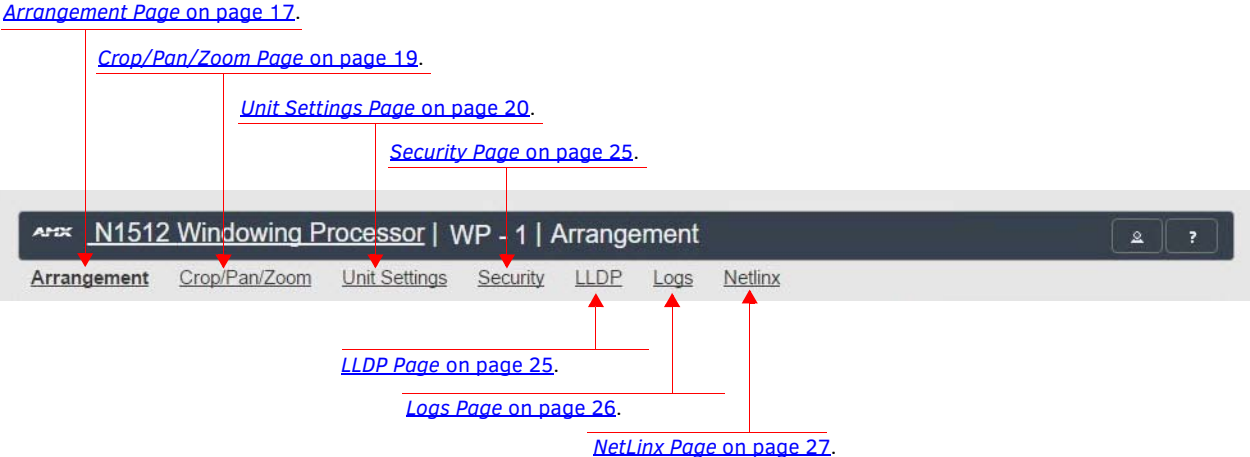

FIG. 8 Section Links



## Arrangement Page

Click the **Arrangement** link at the top of any of the main web pages to access the page shown in [Figure 9](#). This page is the main control area. It is a combination of arrange, stretch, and skew options.

This area is also used to manipulate other settings such as borders, backgrounds, presets, output mode, and input streams. Select from any number of default or user-defined presets. Slide windows around on command for attention-getting displays while seamlessly switching AV streams in and out as needed. See [Table 2](#) for option descriptions.

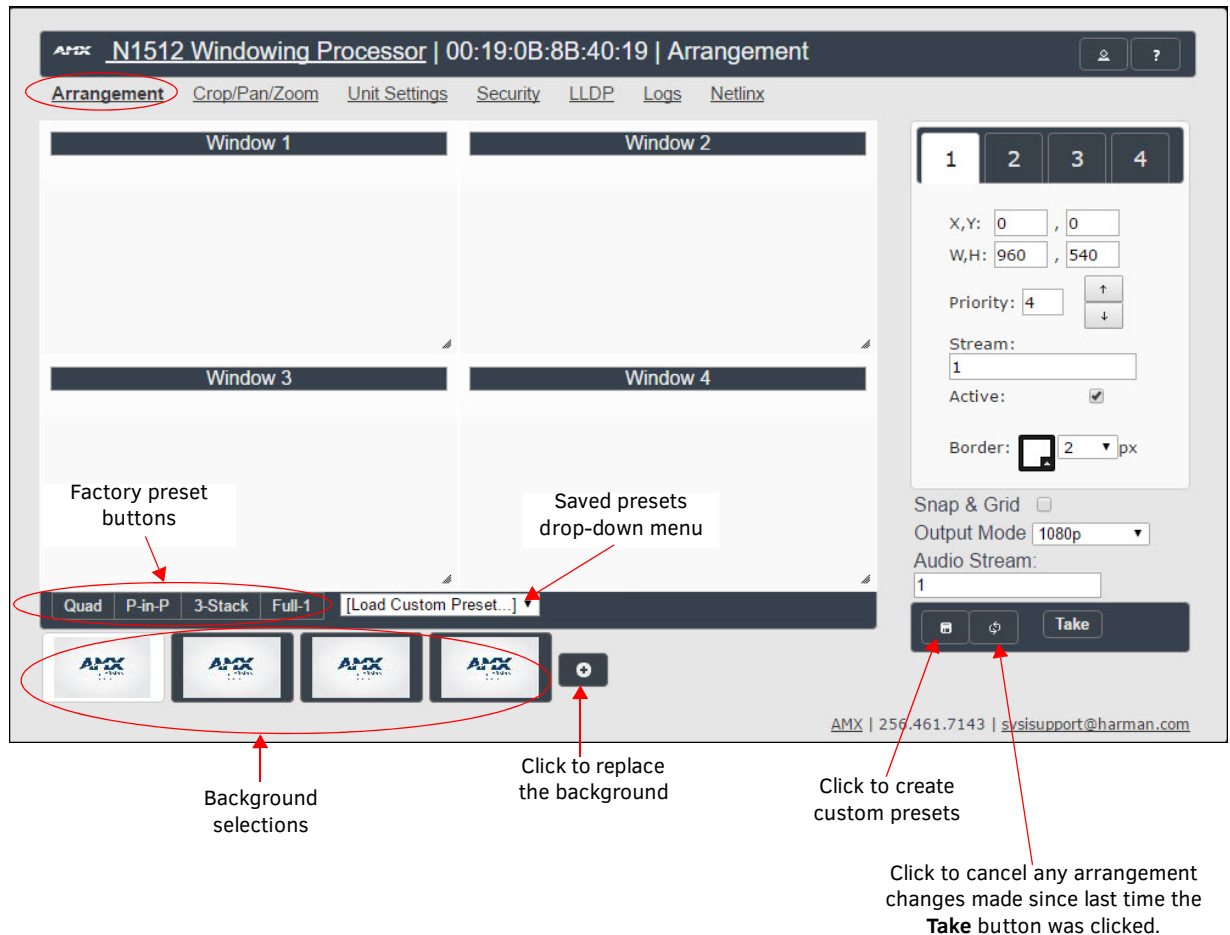





FIG. 9 Arrangement Page

TABLE 2 Arrangement Page Options

Option	Description
<b>Window frames (1-4)</b>	The Window view shown in the left (main) portion of the page represents the overall screen setup you are creating. From here, you can position and stretch windows by dragging-and-dropping, resizing, etc. You can fine-tune adjustments by directly entering values in the fields on the right side of the screen.
<b>Number tabs (1-4)</b>	Select the window for which you would like to view/edit settings.
<b>X, Y coordinates</b>	View/edit the top-left pixel coordinates of the selected window.
<b>W, H</b>	View/edit the width and height (in pixels) of the selected window.
<b>Priority</b>	Set a priority value for window display. When windows overlap each other, this number determines back/front placement. The window with the highest <b>Priority</b> number is in front. For example, if a window with a <b>Priority</b> of 2 overlaps a window with a <b>Priority</b> of 4, the window with <b>Priority</b> 4 will display in front.
<b>Stream</b>	View/edit the input source stream number for the selected window.
<b>Active checkbox</b>	Enable to make the selected window active. If this box is not checked, the window will not be displayed.
<b>Border</b>	View/edit the color and width (in pixels) of the border around the selected window.
<b>Snap and Grid</b>	Enable to have windows snap to the grid edges. If enabled, as you drag a window away from the edge, it automatically aligns to the nearest edge. This keeps windows perfectly aligned and away from center.
<b>Output Mode</b>	View/edit the current output mode for the Windowing Processor.
<b>Audio Stream</b>	View/edit the output audio stream number for the Windowing Processor.

**TABLE 2** Arrangement Page Options (Cont.)

Option	Description
	Described previously in <a href="#">Figure 9</a> .
	Described previously in <a href="#">Figure 9</a> .
<b>Take button</b>	Click <b>Take</b> to apply setting changes.
<b>Factory preset buttons (Quad, P-in-P, etc.)</b>	Click to automatically arrange windows into one of the factory pre-set choices.
<b>Load Custom Preset dropdown</b>	Click to automatically arrange windows into one of the custom pre-set choices saved to this Windowing Processor.
<b>Background Images</b>	Click to choose a background image/color that will appear when a window is not active (or behind the windows if the four windows do not completely fill the output area).
	Described previously in <a href="#">Figure 9</a> .

# Crop/Pan/Zoom Page

Click the **Crop/Pan/Zoom** link at the top of any of the main web pages to access the page shown in [Figure 10](#). This page allows you to access finer control of the individual windows. See [Table 3](#) for option descriptions.



FIG. 10 Crop/Pan/Zoom Page

TABLE 3 Crop/Pan/Zoom Page Options

Option	Description
<b>Window Number tabs (1-4)</b>	Select the window for which you would like to view/edit settings.
<b>X1, Y1</b>	Set pixel coordinates of cropping area (top left).
<b>X2, Y2</b>	Set pixel coordinates of cropping area (bottom right).
<b>Resolution</b>	Displays the current window's resolution.
<b>Aspect Ratio checkbox</b>	Enable <b>Aspect Ratio</b> to restrict crop box re-sizing so that the cropped portion maintains the aspect ratio of the original resolution.
<b>Cancel button</b>	Click to return all controls to the last saved configuration.
<b>Take button</b>	Click <b>Take</b> to apply setting changes.

## Unit Settings Page

Click the **Unit Settings** link at the top of any of the main web pages to access the page shown in [Figure 11](#). The **Unit Settings** page is divided into several sections. Refer to the following sections for detailed descriptions:

- [Unit Setup Section on page 21](#)
- [Stored Presets Section on page 22](#)
- [Network Setup Section on page 23](#)
- [Network Setup for U0-U3 Section on page 24](#)
- [Change Password Section on page 24](#)
- [Software Section on page 24](#)

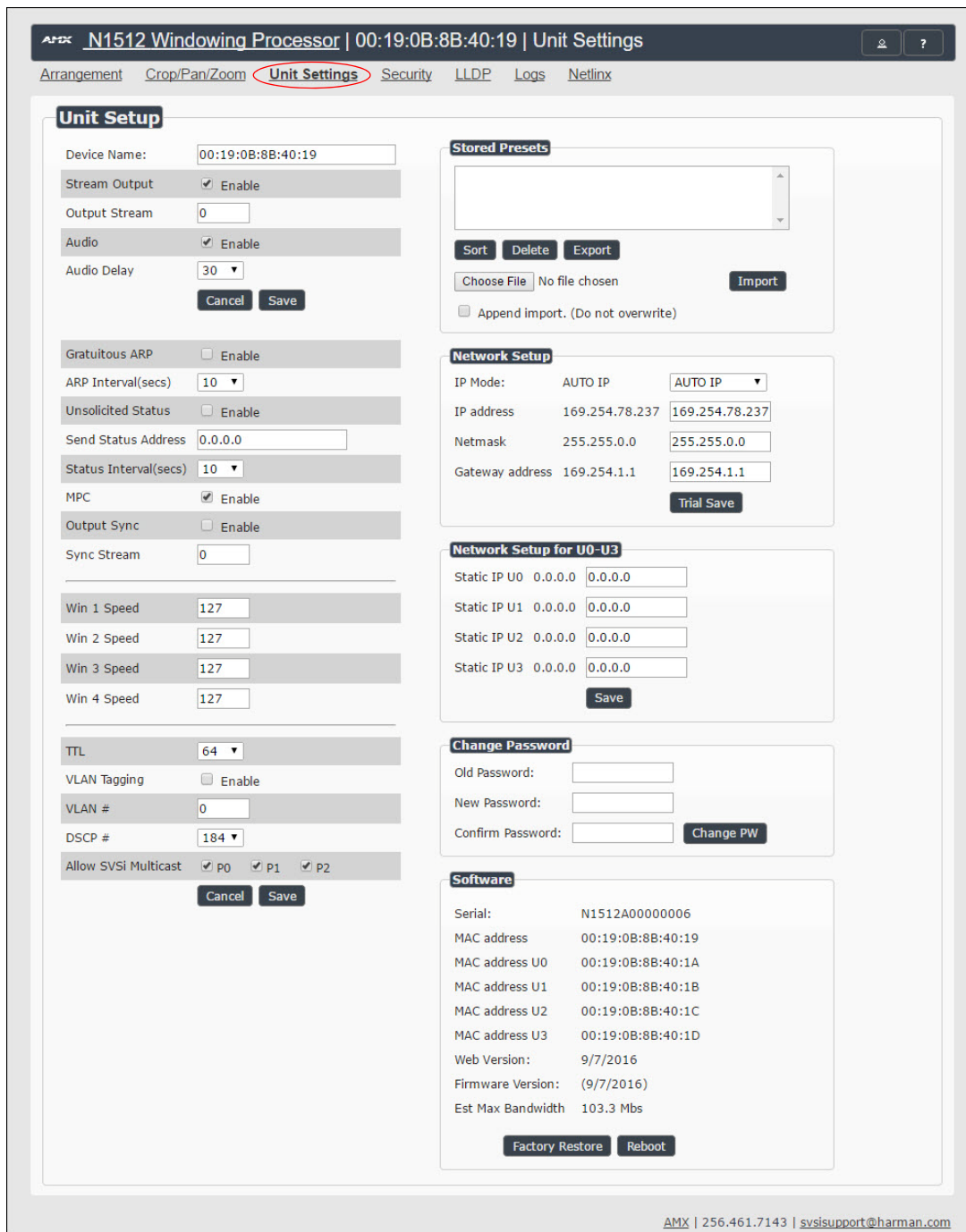

FIG. 11 Unit Settings Page

### Unit Setup Section

The **Unit Setup** section of the **Unit Settings** page is shown in [Figure 12](#). Options are described in [Table 4](#).

**FIG. 12** Unit Setup Section

**TABLE 4** Unit Settings Page: Unit Setup Section

Option	Description	Notes
<b>Device Name</b>	Enter a user-friendly name for the unit.	More descriptive names in this field help you organize and manage the system efficiently. Keep in mind the matrices are organized alphanumerically.
<b>Stream Output</b>	Enable to turn on the output of the Windowing Processor.	Enable this option prior to viewing the output of the N1512 with a Decoder. When enabled, you can route AV streams in N-Able (or your other configuration choice) to the four windows and route the output of the N1512 to an N1000 Decoder to verify operations.
<b>Output Stream</b>	View/edit the current output stream number for the Windowing Processor.	If desired, modify from the default stream number. N-Able (or your other configuration choice) may also prompt for this to be changed when the unit is first discovered.
<b>Audio checkbox</b>	Enable to turn on the audio stream for the Windowing Processor. The <b>Audio Stream</b> number is specified on the <b>Arrangement</b> page (see <a href="#">page 17</a> ).	
<b>Audio Delay</b>	Use to adjust audio output timing delay when needed to sync the audio stream with the video stream.	

TABLE 4 Unit Settings Page: Unit Setup Section (Cont.)

Option	Description	Notes
<b>Gratuitous ARP</b>	Enable the Windowing Processor to send a periodic Address Resolution Protocol (ARP) packet to the network.	
<b>ARP Intervals</b>	Determine how often (in seconds) the unit transmits gratuitous ARP packets.	
<b>Unsolicited Status</b>	Enable the unit to send a periodic status packet to the <b>Send Status Address</b> described next.	
<b>Send Status Address</b>	When <b>Unsolicited Status</b> is enabled, the Windowing Processor sends a periodic status packet to the IP address specified here.	
<b>Status Intervals (secs)</b>	Determine how often (in seconds) the unit transmits status packets.	
<b>MPC</b>	Enable to turn on Minimal Proprietary Compression (MPC) output.	Enabled by default. Uncheck the box to disable MPC mode (resulting in uncompressed output). Leave at default unless using older N-Series equipment that does not have MPC support.
<b>Output Sync</b>	Enable to sync the Windowing Processor video output to the video stream input given by the <b>Sync Stream</b> setting (described next).	
<b>Sync Stream</b>	Enter the video stream number to use to sync the Windowing Processor video output when the <b>Output Sync</b> option is enabled.	
<b>Win 1 - 4 Speed</b>	Set the speed (pixels per frame) to which a window will move to its new location after rearrangement.	
<b>TTL</b>	Select the Time To Live (TTL) for the transmit audio and video streams.	
<b>VLAN Tagging</b>	Enable to have the unit insert a VLAN identification number into the packet headers (in order to identify which VLAN the packet belongs to). The <b>VLAN #</b> setting determines what number is inserted.	
<b>VLAN #</b>	Enter the VLAN identification number. If <b>VLAN Tagging</b> is enabled, this number is added to the packet headers for packet identification purposes.	
<b>DSCP #</b>	Select the Differentiated Services Code Point (DSCP) for the transmit audio and video streams.	
<b>Allow SVSI Multicast</b>	Disable this option to prevent the selected port(s) from outputting multicast video traffic.	Particularly useful if you are connecting a non-SVSI device to a port for network-based control.
<b>Cancel</b>	Click to return all controls to the last saved configuration.	
<b>Save</b>	Click to accept changes made to these controls.	

### Stored Presets Section

The **Stored Presets** section of the **Unit Settings** page is shown in [Figure 13](#). This section allows you to auto-load presets through scripting language and share presets between devices. Options are described in [Table 5](#).

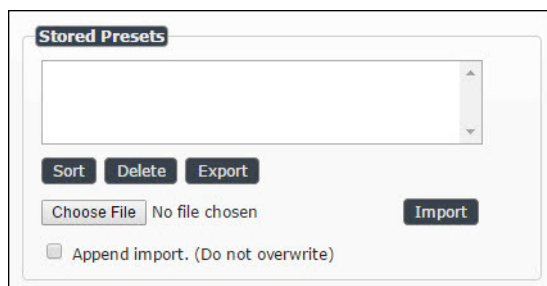

FIG. 13 Stored Presets Section

**TABLE 5** Unit Settings Page: Stored Presets Section

Option	Description	Notes
<b>Stored Presets field</b>	Lists presets already stored in this device.	
<b>Sort button</b>	Click to rearrange and re-index the <b>Stored Presets</b> in any order.	
<b>Delete button</b>	Click to delete the selected stored preset.	
<b>Export button</b>	Click to export the selected stored preset to later import to another Windowing Processor.	
<b>Choose File button</b>	Choose a stored preset file to import to this Windowing Processor.	
<b>Import button</b>	Click to import the preset file chosen using the <b>Choose File</b> button.	
<b>Append Import checkbox</b>	Enable this checkbox if you want to append the current stored presets with the imported presets.	If this option is not enabled, the import will overwrite the currently stored presets.

### Network Setup Section

The **Network Setup** section of the **Unit Settings** page is shown in [Figure 14](#). Options are described in [Table 6](#). In the **Network Setup** section on the **Unit Settings** page:

- **IP address** is required, and will be used as the control IP address.
- Configure the **Netmask** and default **Gateway address** as needed or directed by IT personnel.

**NOTE:** *If you do need to make changes to the Network Setup section, click Trial Save once changes are made. If the control IP address is different from the default, you will need to log in to the unit using its new IP address. Once re-logged back in, click Confirm to keep the changes. If the unit is power cycled before the changes are confirmed, it will revert to its original IP address.*

The screenshot shows the 'Network Setup' section of the configuration page. It includes a dropdown menu for 'IP Mode' currently set to 'AUTO IP'. Below it are four input fields: 'IP address' with the value '169.254.78.237', 'Netmask' with '255.255.0.0', and 'Gateway address' with '169.254.1.1'. A 'Trial Save' button is located at the bottom of the form.

**FIG. 14** Network Setup Section**TABLE 6** Unit Settings Page: Network Setup Section

Option	Description	Notes
<b>IP Mode</b>	Configure the IP address mode. When set to <b>AUTO IP</b> , an IP Address in the range of 169.254.xxx.xxx with <b>Netmask</b> of 255.255.0.0 and <b>Gateway address</b> of 169.254.1.1 will be automatically assigned to the N1512 Windowing Processor by the control software. When set to <b>DHCP</b> , an IP Address in the range of the DHCP server on the network will be automatically assigned to the N1512 Windowing Processor. When set to <b>STATIC</b> , an <b>IP address</b> , <b>Netmask</b> , and <b>Gateway address</b> must be manually entered.	<b>DHCP</b> is the default setting. However, using <b>DHCP</b> beyond initial setup is generally not recommended. If the device is set to <b>DHCP</b> and fails to receive an address from the DHCP server in time, it will revert back to the <b>AUTO IP</b> Address (169.254.xxx.xxx) until the unit is rebooted.
<b>IP address</b>	View the current IP address of the N1512 Windowing Processor. When in <b>STATIC</b> mode, you may enter a new IP address into this field.	
<b>Netmask</b>	View the current <b>Netmask</b> of the N1512 Windowing Processor. When in <b>STATIC</b> mode, you may enter a new <b>Netmask</b> into this field.	
<b>Gateway address</b>	View the current <b>Gateway address</b> of the N1512 Windowing Processor. When in <b>STATIC</b> mode, you may enter a new <b>Gateway address</b> into this field.	
<b>Trial Save</b>	Click to initially save IP address changes. Once you log in to the unit using the new address, you will be able to confirm and accept the changes permanently.	

### Network Setup for U0-U3 Section

The **Network Setup for U0-U3** section of the **Unit Settings** page is shown in [Figure 15](#). Assign unique static IP addresses for each of the U ports. These must be in the same subnet as the rest of the system (i.e., host computer, Windowing Processor, Encoders, etc.). Options are described in [Table 7](#).

**NOTE:** *The U ports do not operate like traditional network ports and will not create a network loop by being connected to the same switch. Therefore, U ports can be connected to the same network switch without causing network issues.*



FIG. 15 Network Setup for U0-U3 Section

TABLE 7 Unit Settings Page: Network Setup for U0-U3 Section

Option	Description
Static IP U0	View/edit the current static IP address of the N1512 Windowing Processor's U0 port.
Static IP U1	View/edit the current static IP address of the N1512 Windowing Processor's U1 port.
Static IP U2	View/edit the current static IP address of the N1512 Windowing Processor's U2 port.
Static IP U3	View/edit the current static IP address of the N1512 Windowing Processor's U3 port.
Save	Save changes made to the <b>Network Setup</b> settings for all U ports.

### Change Password Section

The **Change Password** section of the **Unit Settings** page is shown in [Figure 16](#). To change the N1512 Windowing Processor interface password (for admin-level access) enter the current password in the field labeled **Old Password**, and enter a new password in the **New Password** and **Confirm Password** fields. Click **Change PW** to accept the new password.



FIG. 16 Change Password

**NOTE:** *If using auto-login (through N-Able or N-Command) the admin password needs to match the password stored in N-Able/ N-Command.*

### Software Section

The **Software** section of the **Unit Settings** page is shown in [Figure 17](#). Options are described in [Table 8](#).

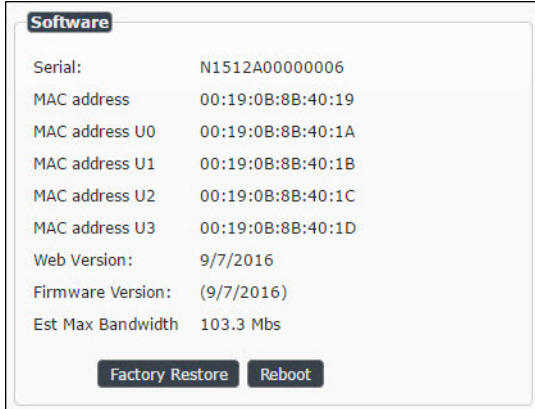

FIG. 17 Software Section



**TABLE 8** Unit Settings Page: Software Section

Option	Description
<b>Serial</b>	Displays the serial number of the Windowing Processor.
<b>MAC Address</b>	Displays the MAC address of the network interface of the Windowing Processor.
<b>MAC Address U0 - U3</b>	Displays the MAC addresses of each of the four U ports on the Windowing Processor.
<b>Web Version</b>	Displays the date code for the currently running version of the web interface.
<b>Firmware Version</b>	Displays the date code for the currently running version of the Windowing Processor internal firmware.
<b>Est Max Bandwidth</b>	Displays the calculated maximum bandwidth for the given output resolution and compression ratio.
<b>Factory Restore</b>	Click to restore the device to the original factory settings. This resets everything except the IP address (including name, stream number, etc.).
<b>Reboot</b>	Click to reboot the device (does not affect current configuration).

## Security Page

Click the **Security** link at the top of any of the main web pages to access the page shown in [Figure 18](#). This page allows you to force HTTPS connections and set up a password for stream encryption. To successfully display an encrypted stream, the **Security** passwords must match on all devices being used (Encoders, Decoders and Windowing Processors).

**NOTE:** This page requires and will redirect to an HTTPS connection.

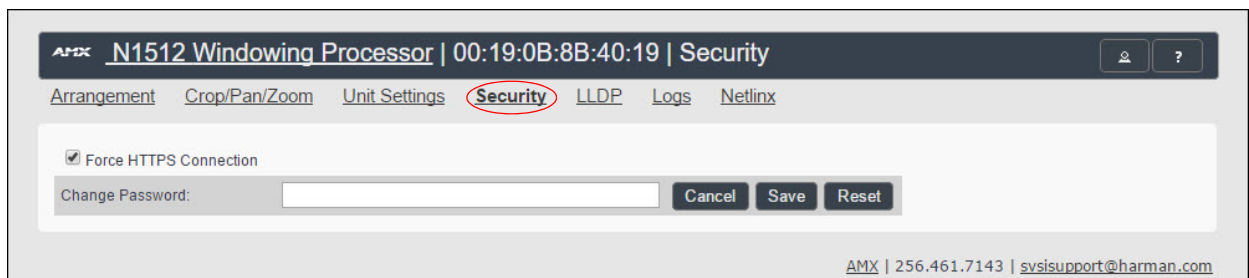
**FIG. 18** Security Page

## LLDP Page

Click the **LLDP** link at the top of any of the main web pages to access the page shown in [Figure 19](#). The **LLDP** page displays information from the Link Layer Discovery Protocol (LLDP) packet which identifies the port number and the switch the device is connected to. The **Sys Name ID**, **Sys Description**, **Port ID**, and **Port Description** fields all reflect the information that was entered on the connected switch's web interface.

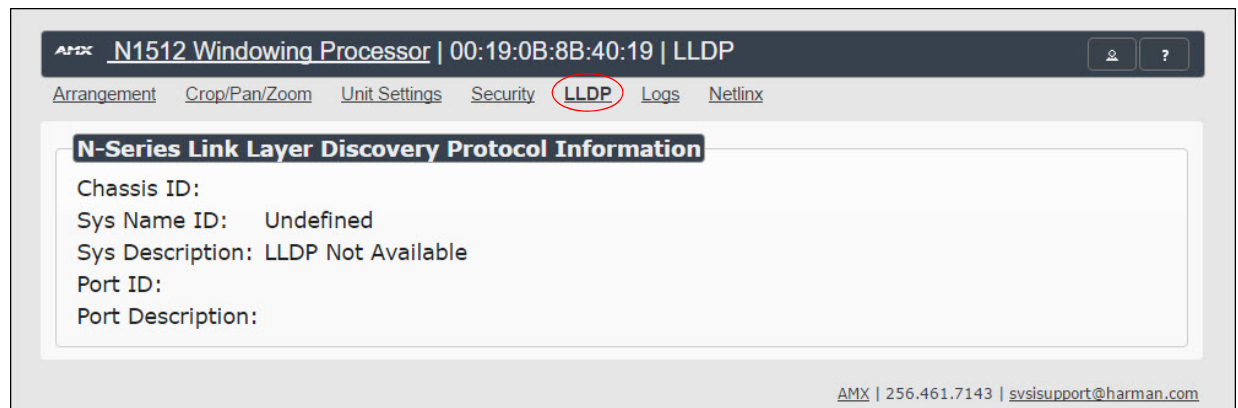
**FIG. 19** LLDP Page

## Logs Page

Click the **Logs** link at the top of any of the main web pages to access the page shown in [Figure 20](#). The **Logs** page displays a command log that lists all TCP and UDP messages the unit receives. It also displays the web browser's IP address and gives you options to **Refresh** and **Reset Logs**.

**NOTE:** All *Debug Log* and *Maintenance Mode* options on this page are troubleshooting tools which should only be used when instructed directly by technical support.

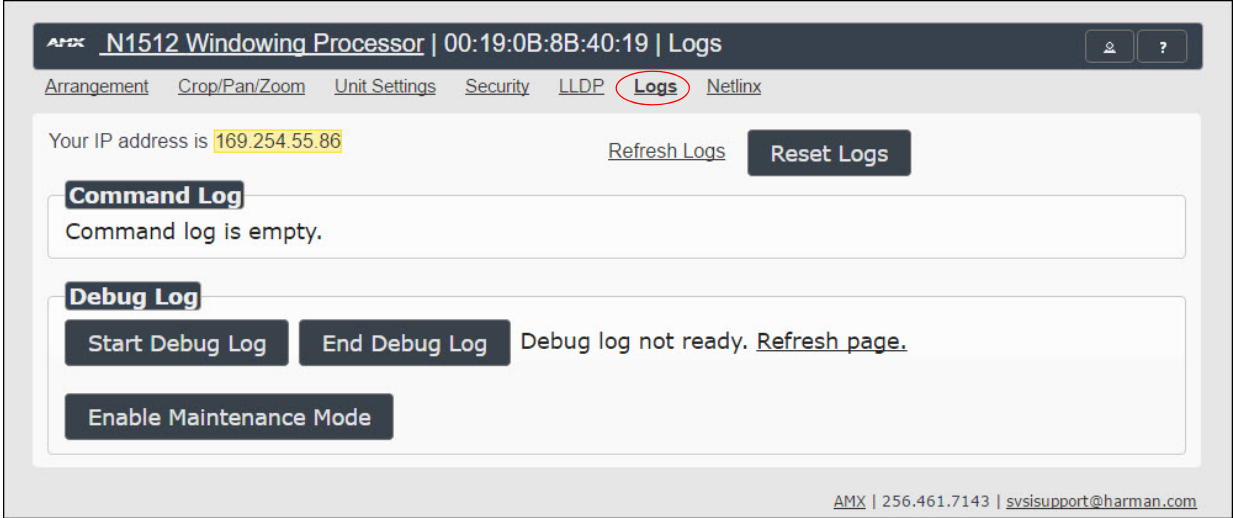

FIG. 20 Logs Page

## NetLinx Page

Click the **NetLinx** link at the top of any of the main web pages to access the page shown in [Figure 21](#). This page allows you to prepare your Windowing Processor for NetLinx-driven configuration. This is explained later in [Appendix A: NetLinx Control on page 29](#).

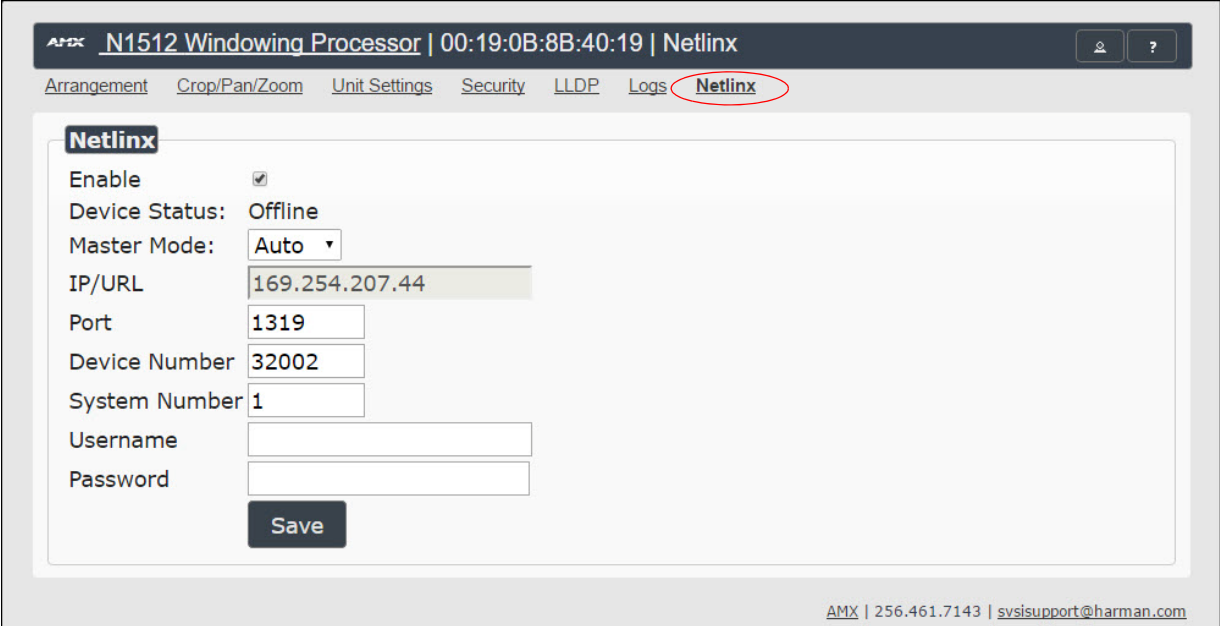

FIG. 21 NetLinx Page

# Chapter 4: Troubleshooting

This chapter contains possible solutions to some common Windowing Processor issues. Should you encounter any problems not covered by these guidelines, please contact technical support via email ([svsisupport@harman.com](mailto:svsisupport@harman.com)) or call 256.461.7143 x9900. You can also visit our support webpage at [support.svsia.com](http://support.svsia.com).

Issues	Suggestions
<b>The N1512 is routed to a Decoder, but the Decoder is showing local play content.</b>	<ul style="list-style-type: none"> <li>• Is <b>Stream Output</b> enabled on the N1512?</li> <li>• Does the N1512 have a Control IP address?</li> <li>• Did you verify that no other devices have the same <b>Output Stream</b> number as the N1512?</li> <li>• Is the Decoder properly assigned to the output of the N1512?</li> <li>• Is the network configured appropriately for N1000 AV traffic?</li> </ul>
<b>The N1512 is routed to a Decoder, but the Decoder only shows four black screens.</b>	<ul style="list-style-type: none"> <li>• Are the source Encoders enabled?</li> <li>• Do you have valid sources connected to all four U ports?</li> <li>• Are the AV sources properly routed to windows of the N1512?</li> <li>• Is the network configured appropriately for N1000 AV traffic?</li> <li>• Did you assign unique IP addresses for each of the <b>U</b> ports? Guidelines for this setting are outlined in <a href="#">Configuring IP addresses (if needed) on page 14</a>.</li> </ul>
<b>Window appears black even though an active Encoder stream is assigned to it.</b>	Verify that the encryption passwords match on all devices being used (Encoders, Decoders and Windowing Processors). See the section <a href="#">Security Page on page 25</a> for more information.
<b>Window displays a portion of the default background image.</b>	Verify that the <b>Active</b> checkbox is enabled. See the section <a href="#">Arrangement Page on page 17</a> for more information.
<b>You cannot access the unit properties after discovery.</b>	Verify that the host PC has an IP address in the same range as the N1512. Double-click the name of the unit to access its properties or use a web browser and access the unit via its IP address.
<b>The web page is not loading or displaying correctly.</b>	Retry using Firefox or Chrome (some versions of Internet Explorer are not supported).

# Appendix A: NetLinx Control

## Introduction

NetLinx Studio is commonly used by system programmers to streamline the integration, programming, organization, and support of their AMX equipment. As the cornerstone of AMX's system design software tools, NetLinx Studio offers programmers the most flexible application capable of generating the most sophisticated code possible. Now equipment in our latest N-Series Networked AV Product comes equipped with NetLinx support. This addendum introduces the new configuration aspects necessary to bring all of your NetLinx-compatible equipment up to speed with the latest functionality. This addendum covers NetLinx functionality as it applies to AMX's N-Series product line - specifically the N1512 Windowing Processor - and is designed to be used as a supplement to additional product documentation found on our website at <http://www.amx.com/techcenter/manuals.asp>.

## Common Applications

NetLinx Studio is a Microsoft Windows program that integrates programming, organization, and support into one application for NetLinx system development.

## NetLinx Configuration Using the Unit's Webpage

From any main page of the unit webpage, click the **NetLinx** tab. See [Figure 22](#). [Table 9](#) provides descriptions for each configuration option.

Click here to access NetLinx configuration options.

AMX | N1512 Windowing Processor | 00:19:0B:8B:40:19 | NetLinx

Arrangement Crop/Pan/Zoom Unit Settings Security LLDP Logs **NetLinx**

**NetLinx Setup**

Enable

Device Status: Online

Master Mode: URL

IP/URL: 192.168.1.200

Port: 1319

Device Number: 8001

System Number: 0

Username: administrator

Password: ●●●●●●

Save

Configuration options available will depend on which **Master Mode** you choose. See [Table 9](#) for more details.

AMX | 256.461.7143 | [svisupport@harman.com](mailto:svisupport@harman.com)

FIG. 22 NetLinx Configuration Page

TABLE 9 NetLinx Configuration Options

Command	Description
Enable	Click to enable/disable NetLinx on this device.
Device Status	This status field will show the device to be <b>Online</b> , <b>Connected</b> , <b>Offline</b> , or <b>Unknown</b> .
Master Mode	Select <b>Auto</b> , <b>Listen</b> , or <b>URL</b> .
IP/URL	Enter the address of the Master Controller.
Port	This field should always be set to <b>1319</b> .
Device Number	Defaults to a dynamic device number. May be set to a static range (e.g., 8000).

TABLE 9 NetLinx Configuration Options (Cont.)

Command	Description
<b>System Number</b>	Determines which system to connect. This setting is dependent upon the <b>Master Mode</b> selected (see above). <ul style="list-style-type: none"> <li>If <b>Master Mode</b> is set to <b>Auto</b>, the <b>System Number</b> is set and the system discovers the Master Controller's IP address.</li> <li>If <b>Master Mode</b> is set to <b>Listen</b>, the device connects to any Master Controller.</li> <li>If <b>Master Mode</b> is set to <b>URL</b>, the IP of the Master Controller is set.</li> </ul>
<b>Username</b>	Username for the Master Controller.
<b>Password</b>	Password for the Master Controller.
<b>Save</b>	Save settings made on this page.

## Batch Configurations Using N-Able

One of the many benefits of using N-Able control is batch configuration. This is especially useful in larger deployments. Instead of using the individual unit web pages (discussed in the previous section), simply open N-Able and select **Tools > Batch Config**. See [Figure 23](#).

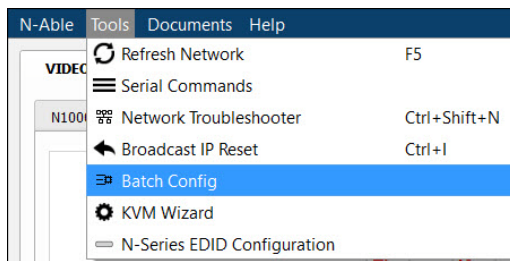

FIG. 23 Selecting Batch Config in N-Able

The screen shown in [Figure 24](#) displays and allows you to choose the units you would like to enable for NetLinx control. To select multiple units, hold down the **<Ctrl>** key. Once all of the units are selected, enable the **NetLinx On** button and click the **OK** button at the bottom of the screen.

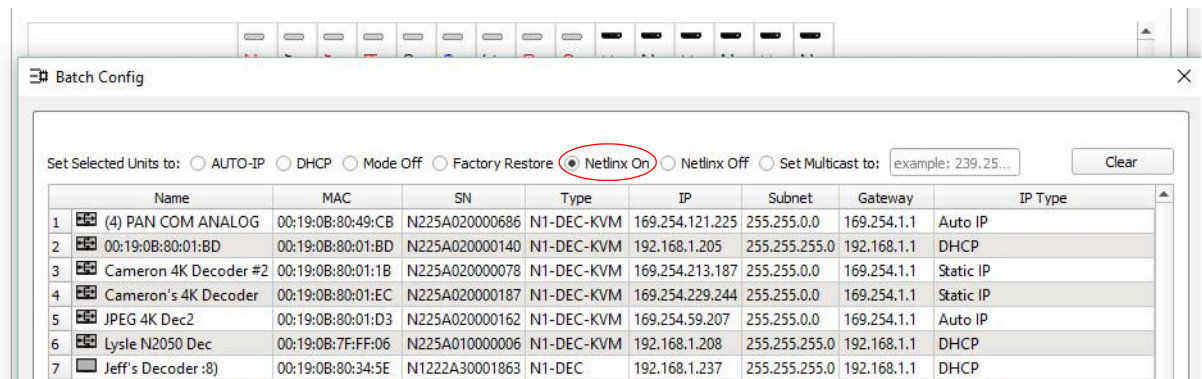

FIG. 24 Enabling NetLinx on Multiple Units

**NOTE:** Items are not filtered. In other words, if you send a NetLinx command to a device that does not support it, the command is simply ignored.

# Windowing Processor Commands

The following section provides information on native and string commands for N-Series Windowing Processors as related to NetLinX management. Native and string commands are issued on Port 1.

## Native Commands Port 1

Command	Description
CO <stream> Set the current output stream number.	<b>IMPORTANT:</b> <i>This command must be sent to D:P:S port 1.</i> <b>Syntax:</b> SEND_COMMAND <DEV>, 'CO <stream>' <b>Variables:</b> stream = The target stream number from 1 to 32767. <b>Examples:</b> SEND_COMMAND 5002:1:0, 'CO 2' Command the windowing processor to transmit on stream 2.
CI <window> <stream> Set the current stream number for window.	<b>IMPORTANT:</b> <i>This command must be sent to D:P:S port 1.</i> <b>Syntax:</b> SEND_COMMAND <DEV>, 'CI <window> <stream>' <b>Variables:</b> window = The target window from 0 to 3. stream = The target stream number from 1 to 32767. <b>Examples:</b> SEND_COMMAND 5002:1:0, 'CI 4 2' Command the windowing processor to receive stream 2 on window 4.
CA <stream> Set the current Decoder Audio stream number.	<b>IMPORTANT:</b> <i>This command must be sent to D:P:S port 1.</i> <b>Syntax:</b> SEND_COMMAND <DEV>, 'CA <stream>' <b>Variables:</b> stream = The target stream number from 0 to 32767. Set to 0 for the audio stream to follow the video stream. <b>Examples:</b> SEND_COMMAND 5002:1:0, 'CA 2' Command the Decoder to receive audio stream 2.
AUDOUT_MUTE Set the audio mute.	<b>IMPORTANT:</b> <i>This command must be sent to D:P:S port 1.</i> <b>Syntax:</b> SEND_COMMAND <DEV>, 'AUDOUT_MUTE-<ENABLE DISABLE>' <b>Variables:</b> ENABLE = Enables audio mute. DISABLE = Disables audio mute. <b>Examples:</b> SEND_COMMAND 5002:1:0, 'AUDOUT_MUTE-ENABLE' Enable audio mute.
VIDOUT_MUTE Disable the Encoder output stream. Disable the Decoder video output stream.	<b>IMPORTANT:</b> <i>This command must be sent to D:P:S port 1.</i> <b>Syntax:</b> SEND_COMMAND <DEV>, 'VIDOUT_MUTE-<ENABLE DISABLE>' <b>Variables:</b> ENABLE = Enables video mute. DISABLE = Disables video mute. <b>Examples:</b> SEND_COMMAND 5002:1:0, 'VIDOUT_MUTE-ENABLE' Enable video mute.
?VIDOUT_OUTPUT Request the current output stream number.	<b>Syntax:</b> SEND_COMMAND <DEV>, '?VIDOUT_OUTPUT' <b>Examples:</b> SEND_COMMAND 5002:1:0, '?VIDOUT_OUTPUT' <b>Command Response:</b> 'VIDOUT_OUTPUT-852'
?VIDIN_INPUT <window> Request the current stream number.	<b>Syntax:</b> SEND_COMMAND <DEV>, '?VIDIN_INPUT <window>' <b>Variables:</b> window = The target window from 0 to 3. <b>Examples:</b> SEND_COMMAND 5002:1:0, '?VIDIN_INPUT 3' <b>Command Response:</b> 'VIDIN_INPUT-852'

## Native Commands Port 1 (Cont.)

Command	Description
?AUDIN_INPUT Request the current audio stream number.	<b>Syntax:</b> SEND_COMMAND <DEV>, '?AUDIN_INPUT' <b>Examples:</b> SEND_COMMAND 5002:1:0, '?AUDIN_INPUT'
?AUDOUT_MUTE Request the state of the audio mute.	<b>Syntax:</b> SEND_COMMAND <DEV>, '?AUDOUT_MUTE' <b>Examples:</b> SEND_COMMAND 5002:1:0, '?AUDOUT_MUTE' <b>Command Response:</b> 'AUDOUT_MUTE-ENABLE'
?VIDOUT_MUTE Request the state of the Encoder stream transmission.	<b>Syntax:</b> SEND_COMMAND <DEV>, '?VIDOUT_MUTE' <b>Examples:</b> SEND_COMMAND 5002:1:0, '?VIDOUT_MUTE' <b>Command Response:</b> 'VIDOUT_MUTE-DISABLE'

## Windowing Processor Pass Through Command Examples

For other commands, the NetLinx String command will interpret any existing N-Series API command. The following sequence of string commands exemplifies the pass through commands used to set up a quad window with white border of two pixels for windows 0 and 1 and no border for windows 2 and 3.

```
SEND_STRING <DEV>, 'winon:0'
SEND_STRING <DEV>, 'set:0:<stream window 0>'
SEND_STRING <DEV>, 'setbordcol:0:255,255,255'
SEND_STRING <DEV>, 'bordon:0'
SEND_STRING <DEV>, 'setbord:0:2,2'
SEND_STRING <DEV>, 'winset:0:0,0,959,539'
SEND_STRING <DEV>, 'setz:0:1'
SEND_STRING <DEV>, 'winon:1'
SEND_STRING <DEV>, 'set:1:<stream window 1>'
SEND_STRING <DEV>, 'setbordcol:1:255,255,255'
SEND_STRING <DEV>, 'bordon:1'
SEND_STRING <DEV>, 'setbord:1:2,2'
SEND_STRING <DEV>, 'winset:1:960,0,1919,539'
SEND_STRING <DEV>, 'setz:1:2'
SEND_STRING <DEV>, 'winon:2'
SEND_STRING <DEV>, 'set:2:<stream window 2>'
SEND_STRING <DEV>, 'setbordcol:2:255,255,255'
SEND_STRING <DEV>, 'bordoff:2'
SEND_STRING <DEV>, 'winset:2:0,540,959,1079'
SEND_STRING <DEV>, 'setz:2:3'
SEND_STRING <DEV>, 'winon:3'
SEND_STRING <DEV>, 'set:3:<stream window 3>'
SEND_STRING <DEV>, 'setbordcol:3:255,255,255'
SEND_STRING <DEV>, 'bordoff:3'
SEND_STRING <DEV>, 'winset:3:960,540,1919,1079'
SEND_STRING <DEV>, 'setz:3:4'
SEND_STRING <DEV>, 'setbkgd:0'
SEND_STRING <DEV>, 'seta:333'
```



# Appendix B: Minimum Network Requirements

The following list specifies the minimum network requirements that must be considered when deploying your equipment. These requirements cover the necessary protocols and features needed to drive N-Series streams.

**NOTE:** *Specific configuration recommendations are based off of the Cisco Catalyst series, however this may vary.*

1. **Managed Network Switch**
2. **Gigabit Ethernet (N1000/2000 Based Systems)**
3. **Internet Group Management Protocol (IGMP) Version 2**
  - IGMP Snooping
  - IGMP Snooping Querying
    - Network must include at least one IGMP Querier to maintain stream connections. It is recommended to have all capable switches with the querier enabled and allow IGMP auto-elect to determine the Designated Querier (DQ).
    - Query interval – 30 seconds. This is the interval between sending IGMP general queries.
    - Query Response Interval – 10 seconds. This is the maximum time the system waits for a response to general queries.
    - Last Member Query Interval – 100 milliseconds. This is the interval to wait for a response to a group specific or group-and-source-specific query message.
    - Immediate Leave (also know as Fast Leave, etc. depending on switch manufacturer).

**NOTE:** *If Immediate Leave is disabled, set IGMP Robustness to Default 2. Robustness can be adjusted generally from 2-10. The higher the value, the more leave latency is added.*

- Warnings/Notices
  - There is a known behavior within IGMP that Encoder streams, whether requested across an uplink or not, will be requested by the DQ and will be present on all uplinks between the stream source switch and the DQ.
    - This means that even though you may not be routing a stream to another switch, the DQ's request still puts the stream on the uplink. Therefore, it is important to account for all streams forwarding to the DQ.
    - The presence of a multicast router with PIM-Sparse configured to handle the multicast traffic may eliminate or limit this behavior.
    - N-Series Encoders also support separate VLAN tagging of audio and video streams to allow only certain audio and video streams through an uplink in order to eliminate or limit this behavior.
- 4. **TCN Flood Off**

TCN flood protocol will cause unnecessary backplane and bandwidth usage when adding or removing a device on the network. This can cause stream interruptions as the flooding sweeps through the network.

Should you encounter any problems not covered by these guidelines, please contact technical support via email ([svsisupport@harman.com](mailto:svsisupport@harman.com)) or call 256.461.7143 x9900.



© 2016 Harman. All rights reserved. AMX, AV FOR AN IT WORLD, and HARMAN, and their respective logos are registered trademarks of HARMAN. Oracle, Java and any other company or brand name referenced may be trademarks/registered trademarks of their respective companies. AMX does not assume responsibility for errors or omissions. AMX also reserves the right to alter specifications without prior notice at any time. The AMX Warranty and Return Policy and related documents can be viewed/downloaded at [www.amx.com](http://www.amx.com).  
**3000 RESEARCH DRIVE, RICHARDSON, TX 75082 AMX.com | 800.222.0193 | 469.624.8000 | +1.469.624.7400 | fax 469.624.7153**  
**AMX (UK) LTD, AMX by HARMAN - Unit C, Auster Road, Clifton Moor, York, YO30 4GD United Kingdom • +44 1904-343-100 • [www.amx.com/eu/](http://www.amx.com/eu/)**

Last Revised:  
11/2016  
850DOCN1512MNRVA